

SIPMOS[®] Power Transistor

- N channel
- Enhancement mode
- Avalanche-rated
- dv/dt rated
- Low on-resistance
- 175°C operating temperature
- also in TO-220 SMD available

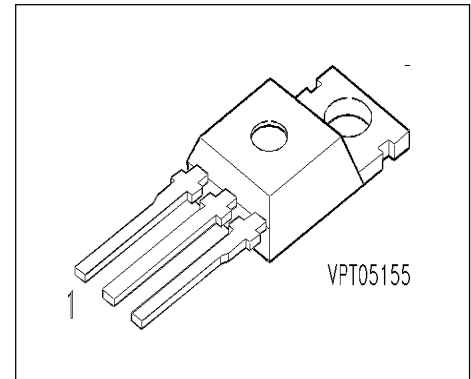

Pin 1	Pin 2	Pin 3
G	D	S

Type	V_{DS}	I_D	$R_{DS(on)}$	Package	Ordering Code
BUZ 103	50 V	40 A	0.04 Ω	TO-220 AB	C67078-S1352-A2

Maximum Ratings

Parameter	Symbol	Values	Unit
Continuous drain current $T_C = 23\text{ }^\circ\text{C}$	I_D	40	A
Pulsed drain current $T_C = 25\text{ }^\circ\text{C}$	I_{Dpuls}	160	A
Avalanche energy, single pulse $I_D = 40\text{ A}$, $V_{DD} = 25\text{ V}$, $R_{GS} = 25\text{ }\Omega$ $L = 63\text{ }\mu\text{H}$, $T_j = 25\text{ }^\circ\text{C}$	E_{AS}	100	mJ
Reverse diode dv/dt $I_S = 40\text{ A}$, $V_{DS} = 40\text{ V}$, $di_F/dt = 200\text{ A}/\mu\text{s}$ $T_{jmax} = 175\text{ }^\circ\text{C}$	dv/dt	6	kV/ μs
Gate source voltage	V_{GS}	± 20	V
Power dissipation $T_C = 25\text{ }^\circ\text{C}$	P_{tot}	120	W
Operating temperature	T_j	-55 ... + 175	$^\circ\text{C}$
Storage temperature	T_{stg}	-55 ... + 175	$^\circ\text{C}$
Thermal resistance, chip case	R_{thJC}	≤ 1.25	K/W
Thermal resistance, chip to ambient	R_{thJA}	≤ 75	K/W
DIN humidity category, DIN 40 040		E	
IEC climatic category, DIN IEC 68-1		55 / 175 / 56	

Electrical Characteristics, at $T_j = 25^\circ\text{C}$, unless otherwise specified

Parameter	Symbol	Values			Unit
		min.	typ.	max.	
Static Characteristics					
Drain- source breakdown voltage $V_{GS} = 0\text{ V}, I_D, T_j = -40\text{ }^\circ\text{C}$	$V_{(BR)DSS}$	50	-	-	V
Gate threshold voltage $V_{GS}=V_{DS}, I_D = 1\text{ mA}$	$V_{GS(th)}$	2.1	3	4	
Zero gate voltage drain current $V_{DS} = 50\text{ V}, V_{GS} = 0\text{ V}, T_j = 25\text{ }^\circ\text{C}$	I_{DSS}	-	0.1	1	μA
$V_{DS} = 50\text{ V}, V_{GS} = 0\text{ V}, T_j = -40\text{ }^\circ\text{C}$		-	1	100	nA
$V_{DS} = 50\text{ V}, V_{GS} = 0\text{ V}, T_j = 150\text{ }^\circ\text{C}$		-	10	100	μA
Gate-source leakage current $V_{GS} = 20\text{ V}, V_{DS} = 0\text{ V}$	I_{GSS}	-	10	100	nA
Drain-Source on-resistance $V_{GS} = 10\text{ V}, I_D = 28\text{ A}$	$R_{DS(on)}$	-	0.03	0.04	Ω

Electrical Characteristics, at $T_j = 25^\circ\text{C}$, unless otherwise specified

Parameter	Symbol	Values			Unit
		min.	typ.	max.	
Dynamic Characteristics					
Transconductance $V_{DS} \geq 2 \cdot I_D \cdot R_{DS(on)max}$, $I_D = 28 \text{ A}$	g_{fs}	10	18	-	S
Input capacitance $V_{GS} = 0 \text{ V}$, $V_{DS} = 25 \text{ V}$, $f = 1 \text{ MHz}$	C_{iss}	-	900	1200	pF
Output capacitance $V_{GS} = 0 \text{ V}$, $V_{DS} = 25 \text{ V}$, $f = 1 \text{ MHz}$	C_{oss}	-	330	500	
Reverse transfer capacitance $V_{GS} = 0 \text{ V}$, $V_{DS} = 25 \text{ V}$, $f = 1 \text{ MHz}$	C_{rss}	-	140	210	
Turn-on delay time $V_{DD} = 30 \text{ V}$, $V_{GS} = 10 \text{ V}$, $I_D = 3 \text{ A}$ $R_{GS} = 50 \Omega$	$t_{d(on)}$	-	20	30	ns
Rise time $V_{DD} = 30 \text{ V}$, $V_{GS} = 10 \text{ V}$, $I_D = 3 \text{ A}$ $R_{GS} = 50 \Omega$	t_r	-	70	105	
Turn-off delay time $V_{DD} = 30 \text{ V}$, $V_{GS} = 10 \text{ V}$, $I_D = 3 \text{ A}$ $R_{GS} = 50 \Omega$	$t_{d(off)}$	-	150	200	
Fall time $V_{DD} = 30 \text{ V}$, $V_{GS} = 10 \text{ V}$, $I_D = 3 \text{ A}$ $R_{GS} = 50 \Omega$	t_f	-	95	130	

Electrical Characteristics, at $T_j = 25^\circ\text{C}$, unless otherwise specified

Parameter	Symbol	Values			Unit
		min.	typ.	max.	
Reverse Diode					
Inverse diode continuous forward current $T_C = 25^\circ\text{C}$	I_S	-	-	40	A
Inverse diode direct current, pulsed $T_C = 25^\circ\text{C}$	I_{SM}	-	-	160	
Inverse diode forward voltage $V_{GS} = 0\text{ V}, I_F = 80\text{ A}$	V_{SD}	-	1.2	1.8	V
Reverse recovery time $V_R = 30\text{ V}, I_F = I_S, di_F/dt = 100\text{ A}/\mu\text{s}$	t_{rr}	-	60	-	ns
Reverse recovery charge $V_R = 30\text{ V}, I_F = I_S, di_F/dt = 100\text{ A}/\mu\text{s}$	Q_{rr}	-	0.08	-	μC

Power dissipation

$$P_{\text{tot}} = f(T_C)$$

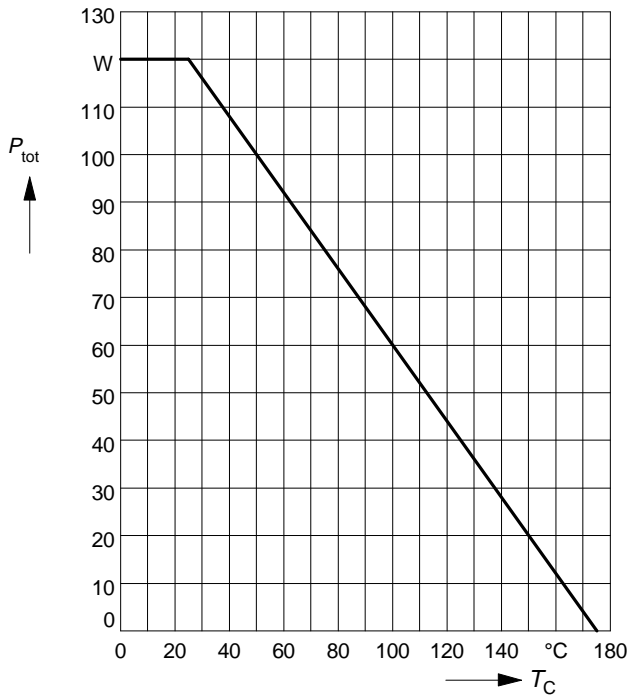

Drain current

$$I_D = f(T_C)$$

parameter: $V_{GS} \geq 10 \text{ V}$

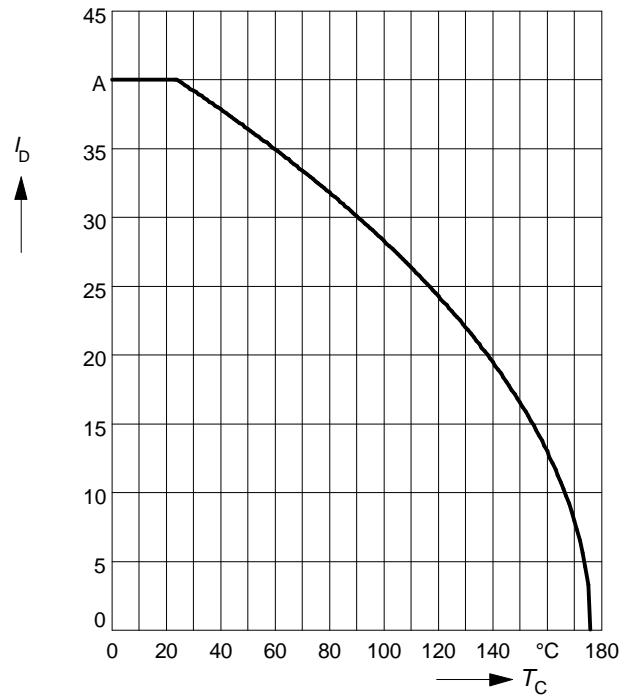

Safe operating area

$$I_D = f(V_{DS})$$

parameter: $D = 0.01$, $T_C = 25^\circ\text{C}$

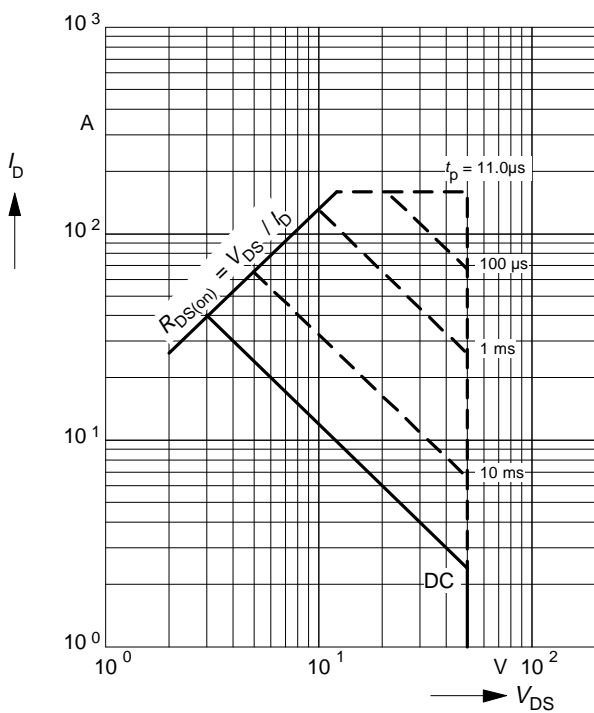

Transient thermal impedance

$$Z_{\text{thJC}} = f(t_p)$$

parameter: $D = t_p / T$

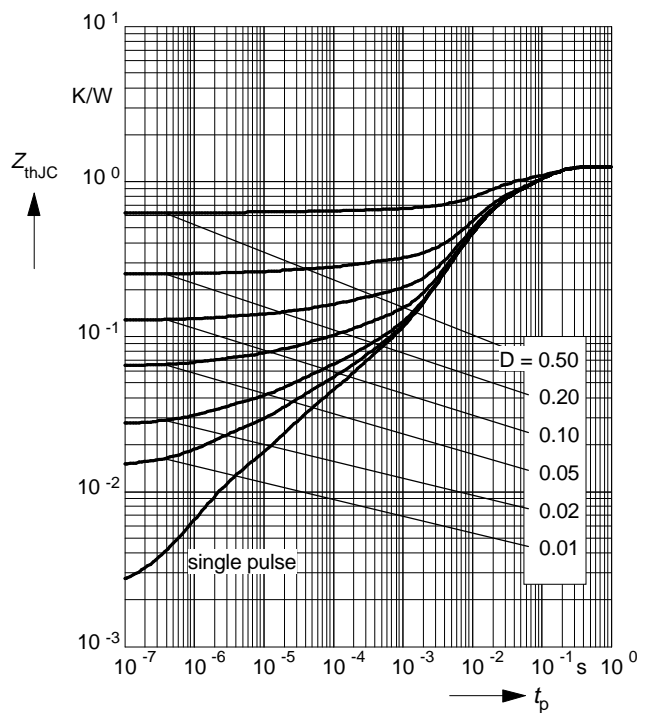

Typ. output characteristics

$$I_D = f(V_{DS})$$

parameter: $t_p = 80 \mu s$

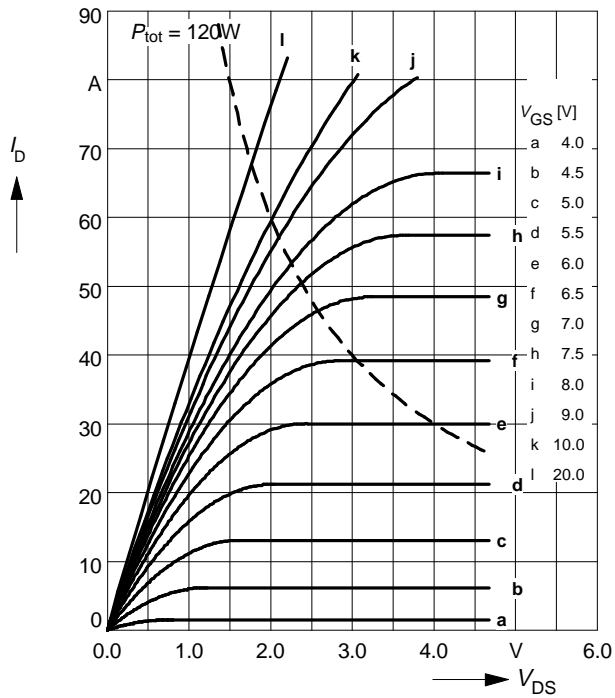

Typ. drain-source on-resistance

$$R_{DS(on)} = f(I_D)$$

parameter: V_{GS}

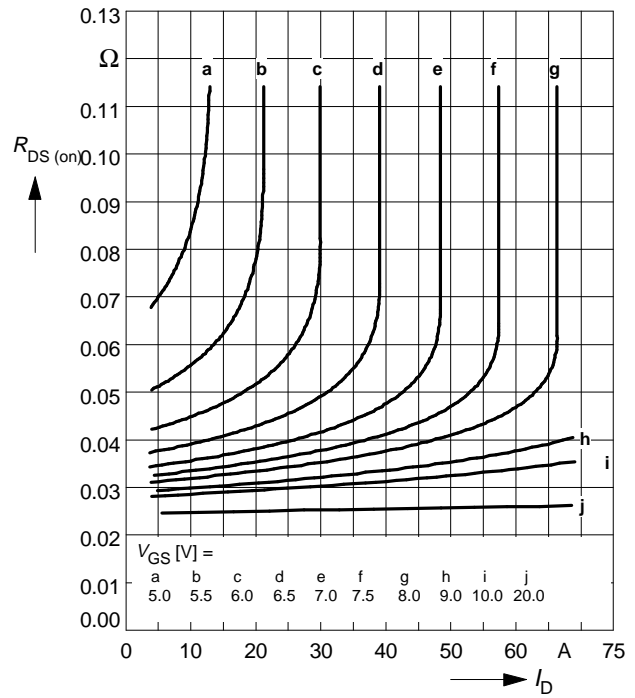

Typ. transfer characteristics $I_D = f(V_{GS})$

parameter: $t_p = 80 \mu s$

$$V_{DS} \geq 2 \times I_D \times R_{DS(on)max}$$

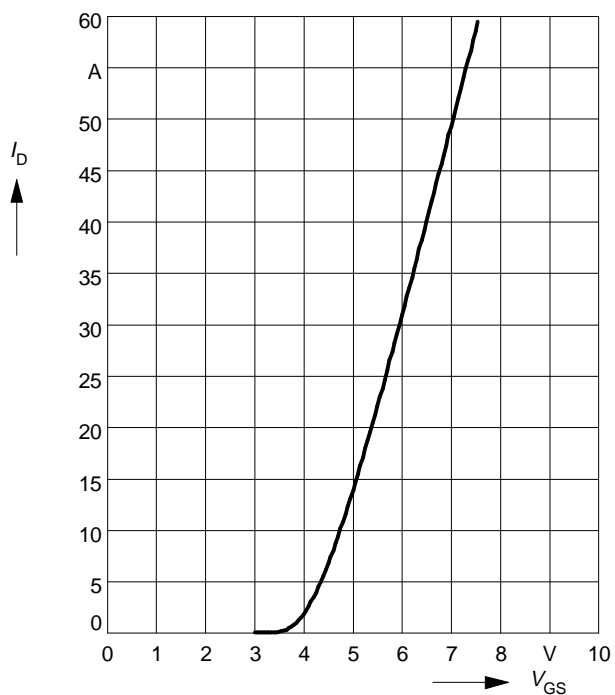

Typ. forward transconductance $g_{fs} = f(I_D)$

parameter: $t_p = 80 \mu s$,

$$V_{DS} \geq 2 \times I_D \times R_{DS(on)max}$$

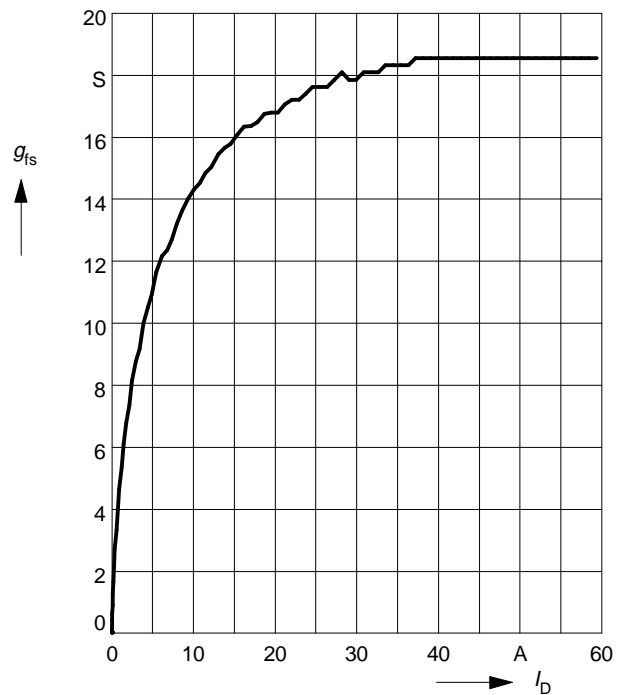

Drain-source on-resistance

$$R_{DS(on)} = f(T_j)$$

parameter: $I_D = 28\text{ A}$, $V_{GS} = 10\text{ V}$

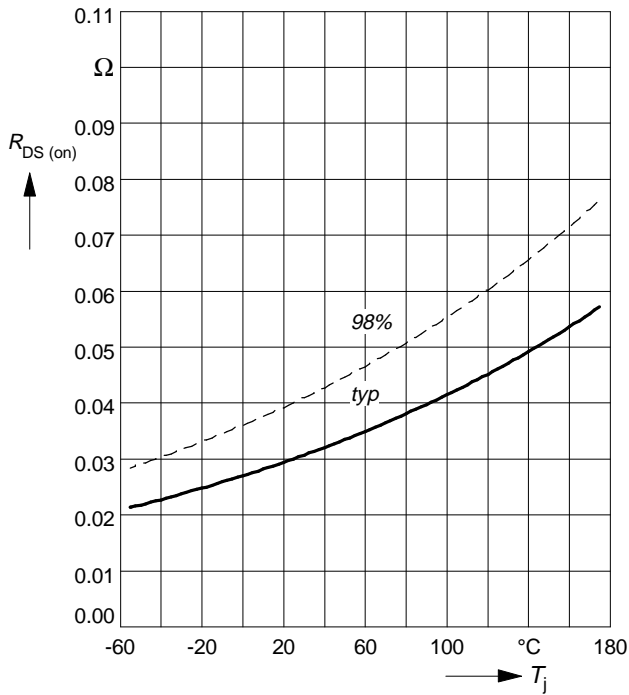

Gate threshold voltage

$$V_{GS(th)} = f(T_j)$$

parameter: $V_{GS} = V_{DS}$, $I_D = 1\text{ mA}$

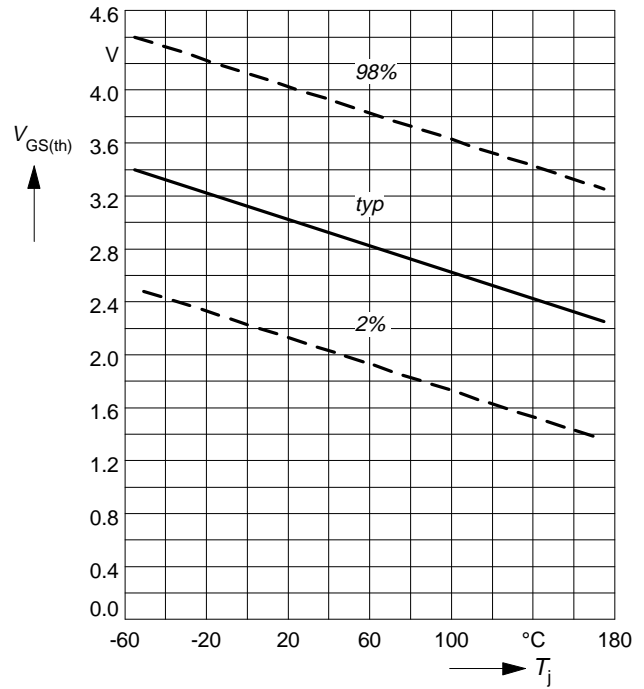

Typ. capacitances

$$C = f(V_{DS})$$

parameter: $V_{GS} = 0\text{ V}$, $f = 1\text{ MHz}$

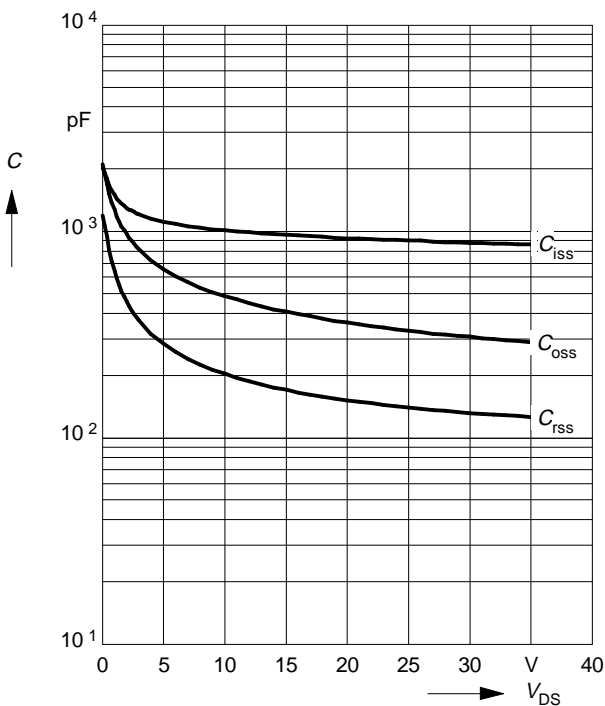

Forward characteristics of reverse diode

$$I_F = f(V_{SD})$$

parameter: T_j , $t_p = 80\text{ }\mu\text{s}$

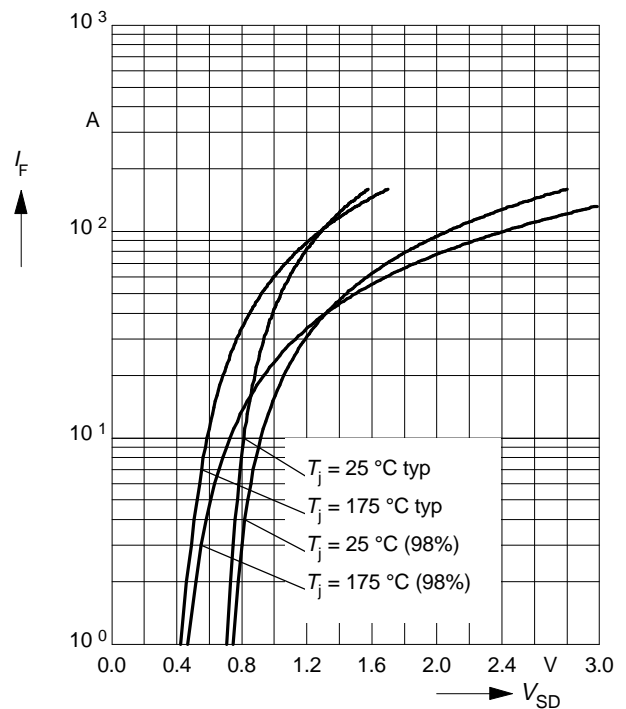

Avalanche energy $E_{AS} = f(T_j)$

parameter: $I_D = 40 \text{ A}$, $V_{DD} = 25 \text{ V}$

$R_{GS} = 25 \Omega$, $L = 63 \mu\text{H}$

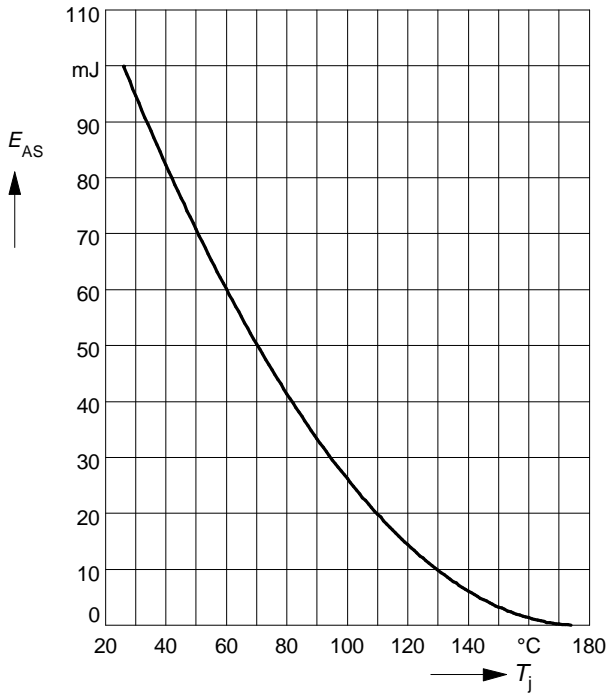

Typ. gate charge $V_{GS} = f(Q_{Gate})$

parameter: $I_{D \text{ puls}} = 60 \text{ A}$

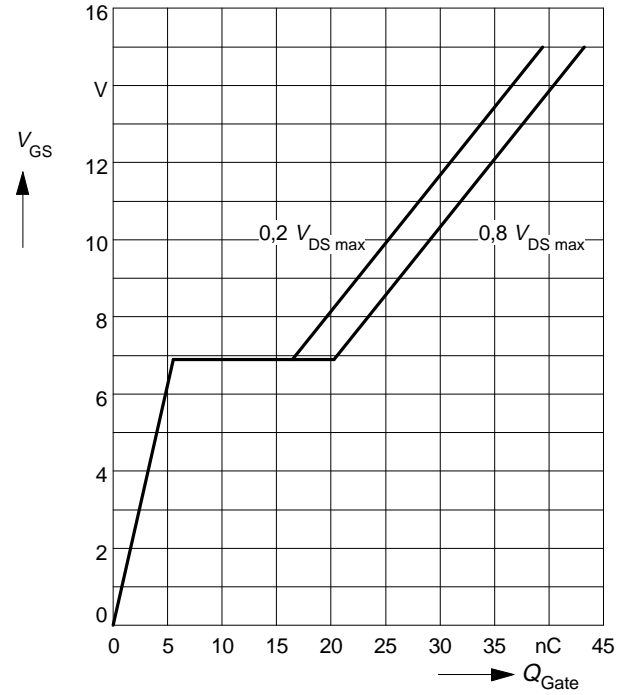

Drain-source breakdown voltage $V_{(BR)DSS} = f(T_j)$



Package Outlines

TO-220 AB

Dimension in mm



GPT05155

- 1) punch direction, burr max. 0.04
- 2) dip tinning
- 3) max. 14.5 by dip tinning press burr max. 0.05