

## Reflective Optical Sensor with Transistor Output

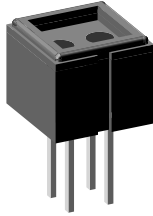

19158

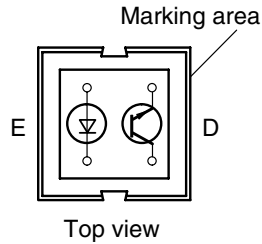

### DESCRIPTION

The CNY70 is a reflective sensor that includes an infrared emitter and phototransistor in a leaded package which blocks visible light.

### FEATURES

- Package type: leaded
- Detector type: phototransistor
- Dimensions (L x W x H in mm): 7 x 7 x 6
- Peak operating distance: < 0.5 mm
- Operating range within > 20 % relative collector current: 0 mm to 5 mm
- Typical output current under test:  $I_C = 1$  mA
- Lead (Pb)-free soldering released
- Compliant to RoHS directive 2002/95/EC and in accordance to WEEE 2002/96/EC
- Emitter wavelength: 950 nm
- Daylight blocking filter

**RoHS**  
COMPLIANT

### APPLICATIONS

- Optoelectronic scanning and switching devices i.e., index sensing, coded disk scanning etc. (optoelectronic encoder assemblies).

### PRODUCT SUMMARY

PART NUMBER	DISTANCE FOR MAXIMUM CTR <sub>rel</sub> <sup>(1)</sup> (mm)	DISTANCE RANGE FOR RELATIVE I <sub>out</sub> > 20 % (mm)	TYPICAL OUTPUT CURRENT UNDER TEST <sup>(2)</sup> (mA)	DAYLIGHT BLOCKING FILTER INTEGRATED
CNY70	0	0 to 5	1	Yes

#### Notes

<sup>(1)</sup> CTR: current transfere ratio,  $I_{out}/I_{in}$

<sup>(2)</sup> Conditions like in table basic characteristics/sensors

### ORDERING INFORMATION

ORDERING CODE	PACKAGING	VOLUME <sup>(1)</sup>	REMARKS
CNY70	Tube	MOQ: 4000 pcs, 80 pcs/tube	-

#### Note

<sup>(1)</sup> MOQ: minimum order quantity

### ABSOLUTE MAXIMUM RATINGS<sup>(1)</sup>

PARAMETER	TEST CONDITION	SYMBOL	VALUE	UNIT
<b>COUPLER</b>				
Total power dissipation	$T_{amb} \leq 25$ °C	$P_{tot}$	200	mW
Ambient temperature range		$T_{amb}$	- 40 to + 85	°C
Storage temperature range		$T_{stg}$	- 40 to + 100	°C
Soldering temperature	Distance to case 2 mm, $t \leq 5$ s	$T_{sd}$	260	°C
<b>INPUT (EMITTER)</b>				
Reverse voltage		$V_R$	5	V
Forward current		$I_F$	50	mA
Forward surge current	$t_p \leq 10$ $\mu$ s	$I_{FSM}$	3	A
Power dissipation	$T_{amb} \leq 25$ °C	$P_V$	100	mW
Junction temperature		$T_j$	100	°C

ABSOLUTE MAXIMUM RATINGS (1)				
PARAMETER	TEST CONDITION	SYMBOL	VALUE	UNIT
<b>OUTPUT (DETECTOR)</b>				
Collector emitter voltage		$V_{CEO}$	32	V
Emitter collector voltage		$V_{ECO}$	7	V
Collector current		$I_C$	50	mA
Power dissipation	$T_{amb} \leq 25\text{ }^\circ\text{C}$	$P_V$	100	mW
Junction temperature		$T_j$	100	$^\circ\text{C}$

**Note**

(1)  $T_{amb} = 25\text{ }^\circ\text{C}$ , unless otherwise specified

**ABSOLUTE MAXIMUM RATINGS**

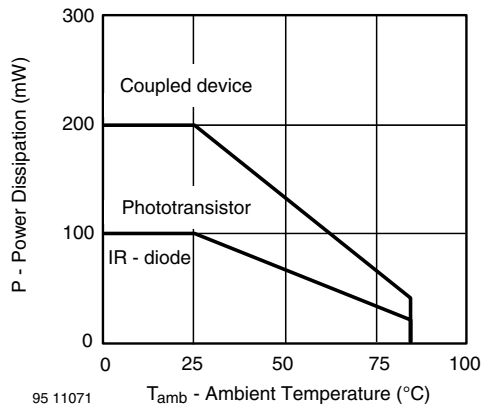
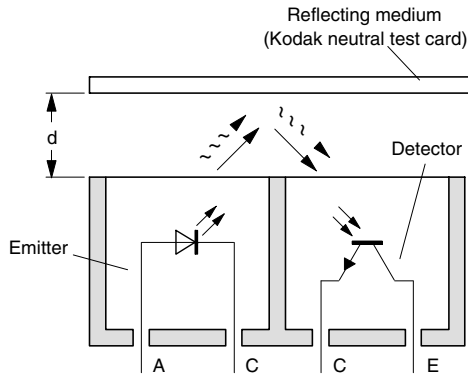

Fig. 1 - Power Dissipation vs. Ambient Temperature

BASIC CHARACTERISTICS (1)						
PARAMETER	TEST CONDITION	SYMBOL	MIN.	TYP.	MAX.	UNIT
<b>COUPLER</b>						
Collector current	$V_{CE} = 5\text{ V}$ , $I_F = 20\text{ mA}$ , $d = 0.3\text{ mm}$ (figure 1)	$I_C$ (2)	0.3	1.0		mA
Cross talk current	$V_{CE} = 5\text{ V}$ , $I_F = 20\text{ mA}$ , (figure 2)	$I_{CX}$ (3)			600	nA
Collector emitter saturation voltage	$I_F = 20\text{ mA}$ , $I_C = 0.1\text{ mA}$ , $d = 0.3\text{ mm}$ (figure 1)	$V_{CEsat}$ (2)			0.3	V
<b>INPUT (EMITTER)</b>						
Forward voltage	$I_F = 50\text{ mA}$	$V_F$		1.25	1.6	V
Radiant intensity	$I_F = 50\text{ mA}$ , $t_p = 20\text{ ms}$	$I_e$			7.5	mW/sr
Peak wavelength	$I_F = 100\text{ mA}$	$\lambda_P$	940			nm
Virtual source diameter	Method: 63 % encircled energy	$d$		1.2		mm
<b>OUTPUT (DETECTOR)</b>						
Collector emitter voltage	$I_C = 1\text{ mA}$	$V_{CEO}$	32			V
Emitter collector voltage	$I_E = 100\text{ }\mu\text{A}$	$V_{ECO}$	5			V
Collector dark current	$V_{CE} = 20\text{ V}$ , $I_F = 0\text{ A}$ , $E = 0\text{ lx}$	$I_{CEO}$			200	nA

**Notes**

- (1)  $T_{amb} = 25\text{ }^\circ\text{C}$ , unless otherwise specified
- (2) Measured with the "Kodak neutral test card", white side with 90 % diffuse reflectance
- (3) Measured without reflecting medium



95 10808

Fig. 2 - Pulse diagram

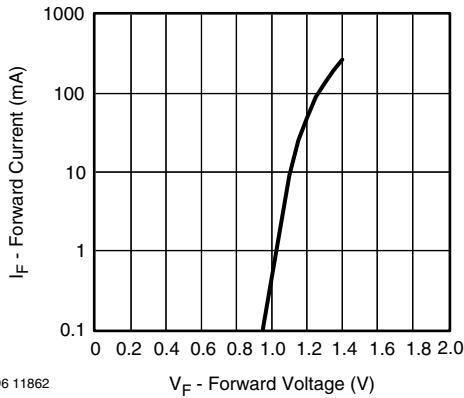
**BASIC CHARACTERISTICS**
 $T_{amb} = 25\text{ }^{\circ}\text{C}$ , unless otherwise specified

96 11862

Fig. 3 - Forward Current vs. Forward Voltage

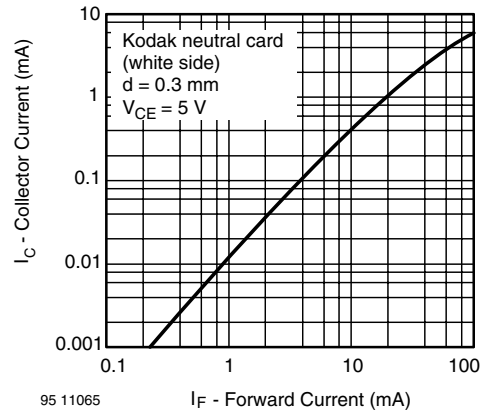

95 11065

Fig. 5 - Collector Current vs. Forward Current

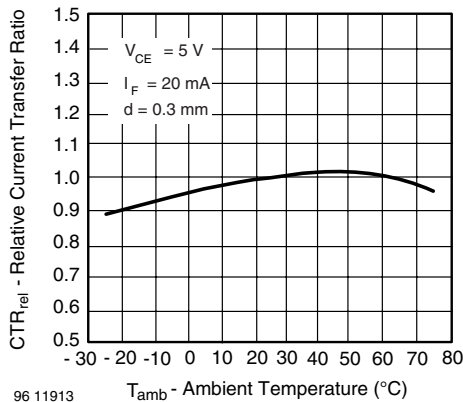

96 11913

Fig. 4 - Relative Current Transfer Ratio vs. Ambient Temperature

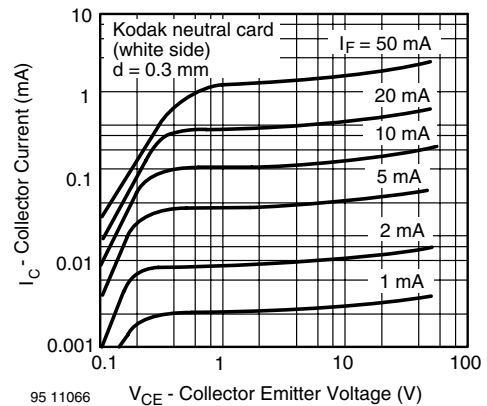

95 11066

Fig. 6 - Collector Current vs. Collector Emitter Voltage

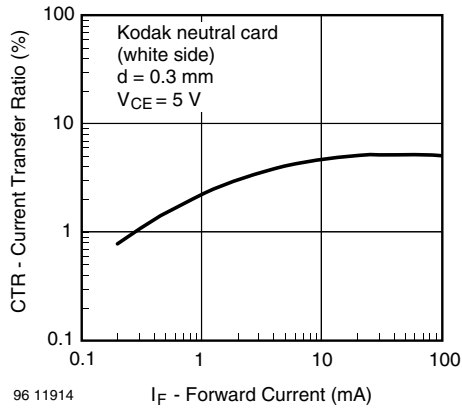

Fig. 7 - Current Transfer Ratio vs. Forward Current

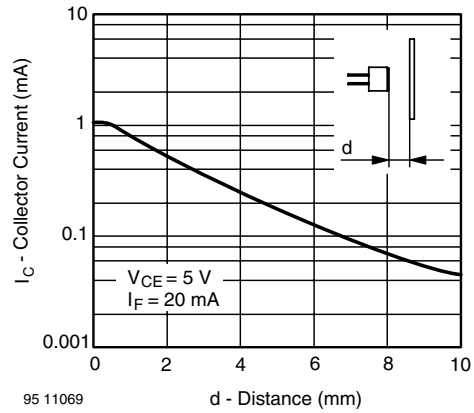

Fig. 9 - Collector Current vs. Distance

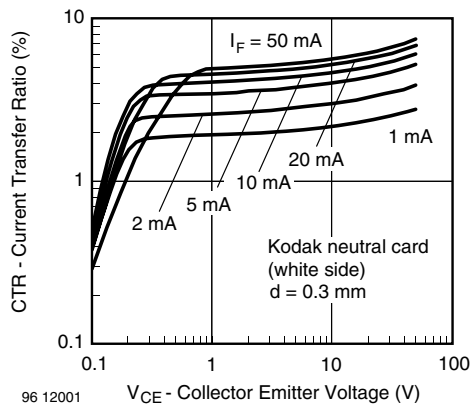

Fig. 8 - Current Transfer Ratio vs. Collector Emitter Voltage

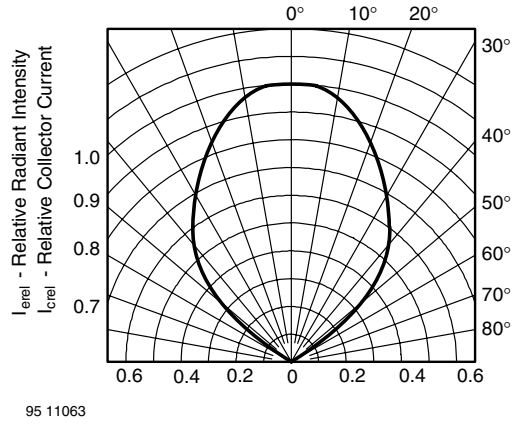

Fig. 10 - Relative Radiant Intensity/Collector Current vs. Angular Displacement

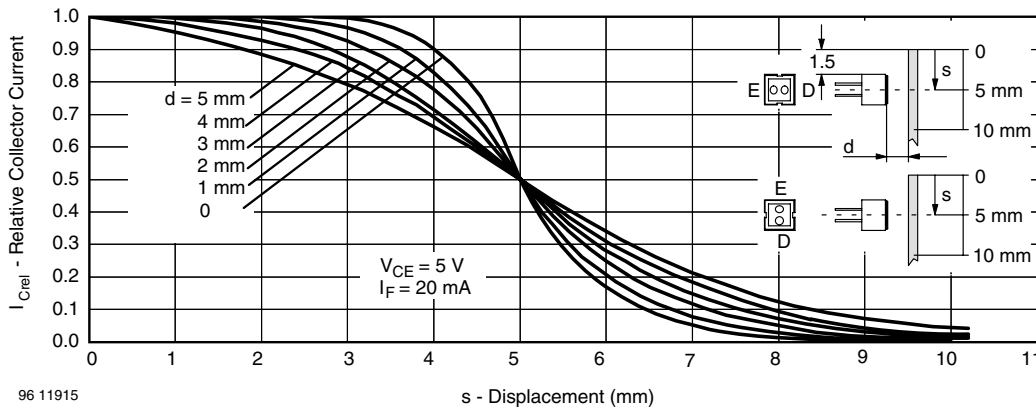
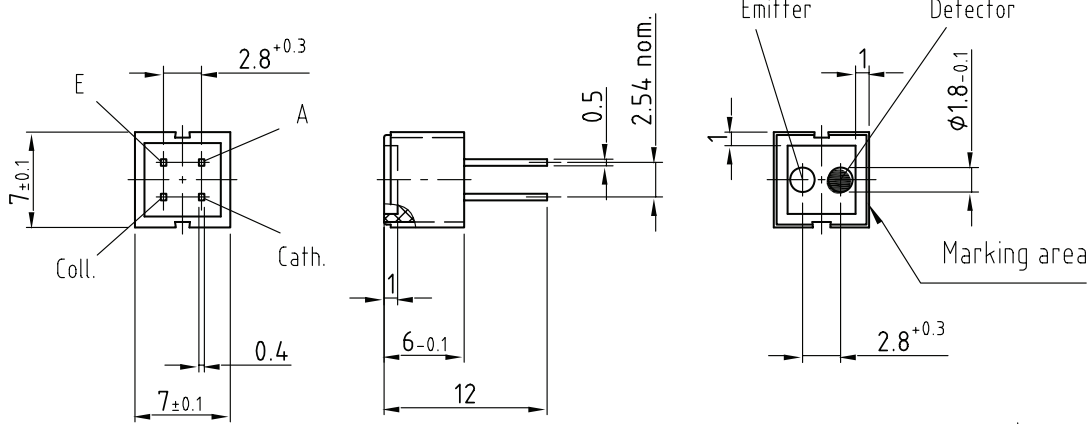
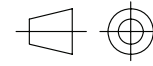

Fig. 11 - Relative Collector Current vs. Displacement

**PACKAGE DIMENSIONS** in millimeters

weight: ca. 0.70g



technical drawings according to DIN specifications

Drawing-No.: 6.544-5062.01-4

Issue: 6; 03.05.06

95 11345

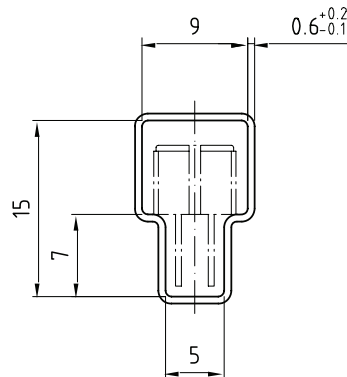
**TUBE DIMENSIONS** in millimeters

 With rubber stopper  
 Tolerance:  $\pm 0.5$ mm  
 Length:  $575 \pm 1$ mm

Drawing-No.: 9.700-5097.01-4

Issue: 1; 25.02.00

20291



## Disclaimer

All product specifications and data are subject to change without notice.

Vishay Intertechnology, Inc., its affiliates, agents, and employees, and all persons acting on its or their behalf (collectively, "Vishay"), disclaim any and all liability for any errors, inaccuracies or incompleteness contained herein or in any other disclosure relating to any product.

Vishay disclaims any and all liability arising out of the use or application of any product described herein or of any information provided herein to the maximum extent permitted by law. The product specifications do not expand or otherwise modify Vishay's terms and conditions of purchase, including but not limited to the warranty expressed therein, which apply to these products.

No license, express or implied, by estoppel or otherwise, to any intellectual property rights is granted by this document or by any conduct of Vishay.

The products shown herein are not designed for use in medical, life-saving, or life-sustaining applications unless otherwise expressly indicated. Customers using or selling Vishay products not expressly indicated for use in such applications do so entirely at their own risk and agree to fully indemnify Vishay for any damages arising or resulting from such use or sale. Please contact authorized Vishay personnel to obtain written terms and conditions regarding products designed for such applications.

Product names and markings noted herein may be trademarks of their respective owners.