

CNY35X  
CNY35



**A.C. INPUT PHOTOTRANSISTOR  
OPTICALLY COUPLED  
ISOLATORS**

**APPROVALS**

- UL recognised, File No. E91231

**'X' SPECIFICATION APPROVALS**

- VDE 0884 in 2 available lead forms : -  
- STD  
- G form
- EN60950 approval pending

**DESCRIPTION**

The Solid State CNY35 optically coupled isolator consists of two infrared light emitting diodes connected in inverse parallel and NPN silicon photo transistor in a standard 6 pin dual in line plastic package.

**FEATURES**

- Options :-  
10mm lead spread - add G after part no.  
Surface mount - add SM after part no.  
Tape&reel - add SMT&R after part no.
- High Isolation Voltage (5.3kV<sub>RMS</sub>, 7.5kV<sub>PK</sub>)
- AC or polarity insensitive input
- All electrical parameters 100% tested
- Custom electrical selections available

**APPLICATIONS**

- Computer terminals
- Industrial systems controllers
- Telephone sets, Telephone exchangers
- Signal transmission between systems of different potentials and impedances

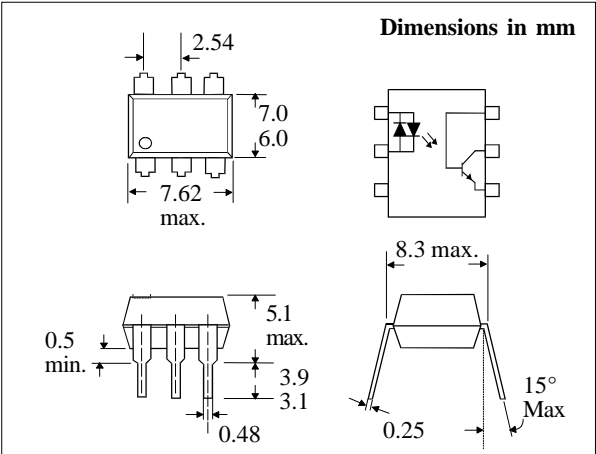

**ABSOLUTE MAXIMUM RATINGS  
(25°C unless otherwise specified)**

Storage Temperature \_\_\_\_\_ -55°C to + 150°C  
 Operating Temperature \_\_\_\_\_ -55°C to + 100°C  
 Lead Soldering Temperature  
 (1/16 inch (1.6mm) from case for 10 secs) 260°C

**INPUT DIODE**

Forward Current \_\_\_\_\_ ±100mA  
 Peak Forward Current \_\_\_\_\_ ±1A  
 Power Dissipation \_\_\_\_\_ 200mW

**OUTPUT TRANSISTOR**

Collector-emitter Voltage BV<sub>CEO</sub> \_\_\_\_\_ 30V  
 Collector-base Voltage BV<sub>CBO</sub> \_\_\_\_\_ 70V  
 Emitter-collector Voltage BV<sub>ECO</sub> \_\_\_\_\_ 7V  
 Emitter-base Voltage BV<sub>EBO</sub> \_\_\_\_\_ 5V  
 Power Dissipation \_\_\_\_\_ 300mW

**POWER DISSIPATION**

Total Power Dissipation \_\_\_\_\_ 350mW  
 (derate linearly 4.67mW/°C above 25°C)

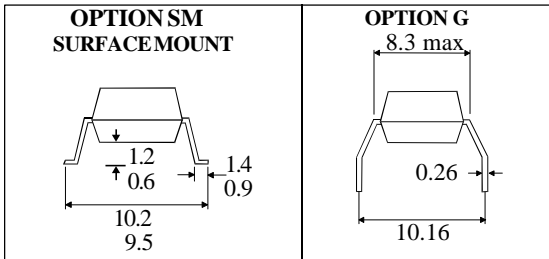

**ISOCOM COMPONENTS LTD**  
 Unit 25B, Park View Road West,  
 Park View Industrial Estate, Brenda Road  
 Hartlepool, Cleveland, TS25 1YD  
 Tel: (01429) 863609 Fax :(01429) 863581

**ISOCOM INC**  
 1024 S. Greenville Ave, Suite 240,  
 Allen, TX 75002 USA  
 Tel: (214)495-0755 Fax: (214)495-0901  
 e-mail info@isocom.com  
 http://www.isocom.com

**ELECTRICAL CHARACTERISTICS (  $T_A = 25^\circ\text{C}$  Unless otherwise noted )**

PARAMETER		MIN	TYP	MAX	UNITS	TEST CONDITION
Input	Forward Voltage ( $V_F$ )		1.2	1.5	V	$I_F = \pm 10\text{mA}$
Output	Collector-emitter Breakdown ( $BV_{CEO}$ ) ( note 2 )	30			V	$I_C = 1\text{mA}$
	Collector-base Breakdown ( $BV_{CBO}$ )	70			V	$I_C = 100\mu\text{A}$
	Emitter-base Breakdown ( $BV_{EBO}$ )	5			V	$I_E = 100\mu\text{A}$
	Emitter-collector Breakdown ( $BV_{ECO}$ )	7			V	$I_E = 100\mu\text{A}$
	Collector-emitter Dark Current ( $I_{CEO}$ )			50	nA	$V_{CE} = 10\text{V}$
Coupled	Current Transfer Ratio (CTR) (note 2 )	10			%	$\pm 10\text{mA} I_F, 10\text{V } V_{CE}$
	Collector-emitter Saturation Voltage $V_{CE(SAT)}$			0.4	V	$\pm 10\text{mA} I_F, 0.5\text{mA} I_C$
	Input to Output Isolation Voltage $V_{ISO}$	5300 7500			$V_{RMS}$ $V_{PK}$	See note 1 See note 1
	Input-output Isolation Resistance $R_{ISO}$	$5 \times 10^{10}$			$\Omega$	$V_{IO} = 500\text{V}$ (note 1)

Note 1 Measured with input leads shorted together and output leads shorted together.

Note 2 Special Selections are available on request. Please consult the factory.

**Collector Power Dissipation vs. Ambient Temperature**

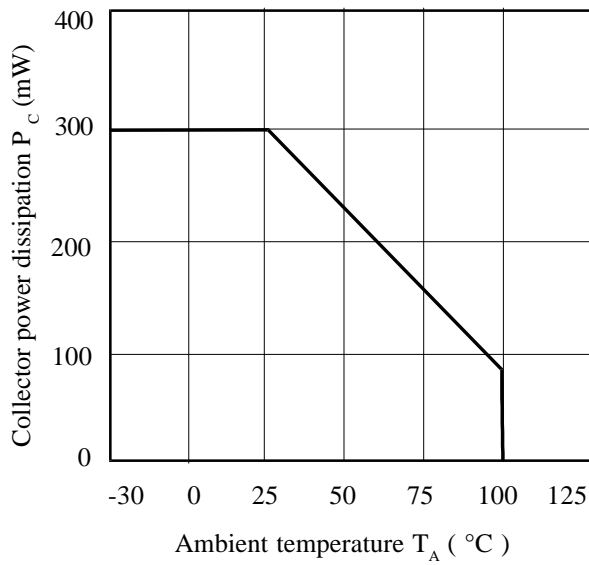

**Forward Current vs. Forward Voltage**

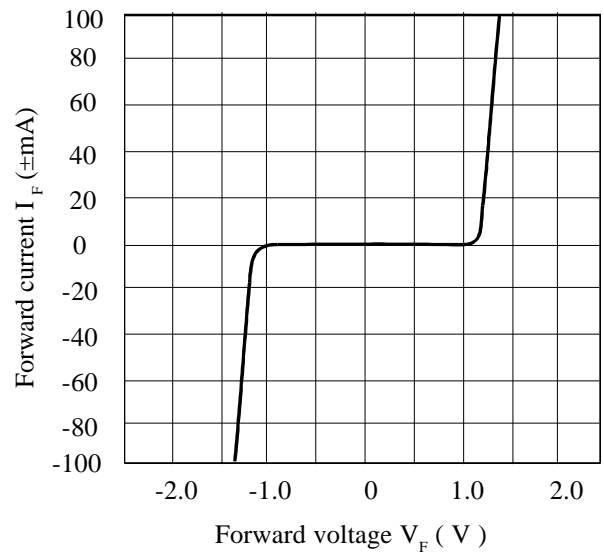

**Forward Current vs. Ambient Temperature**

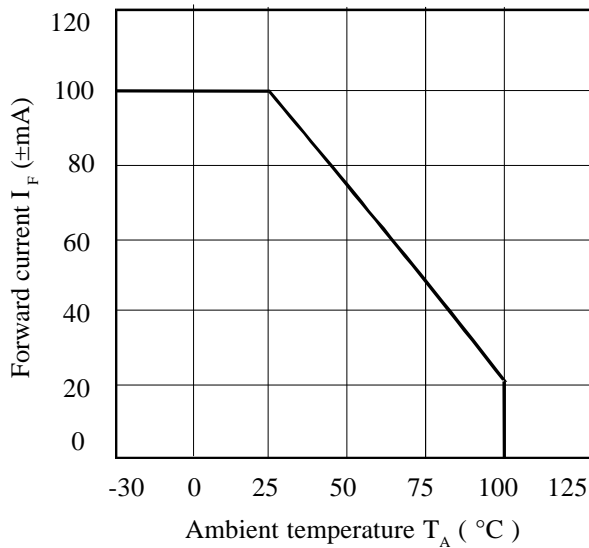

**Normalised Output Current vs. Ambient Temperature**

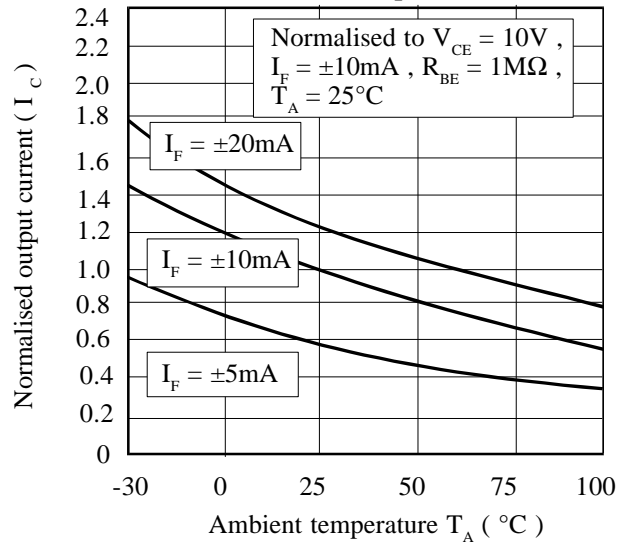

**Normalised Output Current vs. Collector-emitter Voltage**

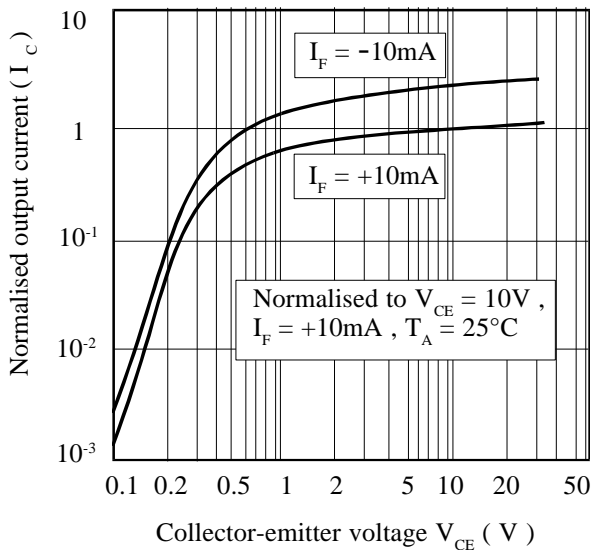

**Normalised Output Current vs. Forward Current**

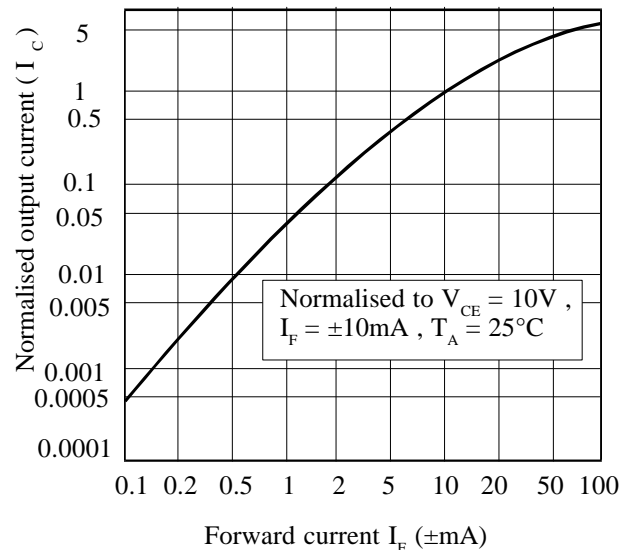

This datasheet has been downloaded from:

[www.DatasheetCatalog.com](http://www.DatasheetCatalog.com)

Datasheets for electronic components.