

PN2222A

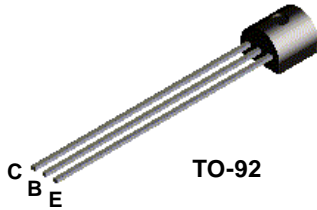

MMBT2222A

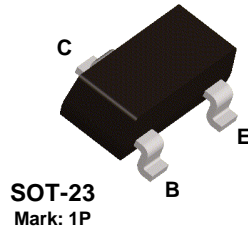

PZT2222A

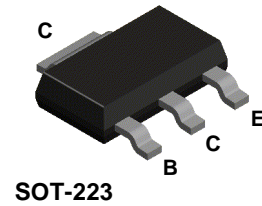

MMPQ2222

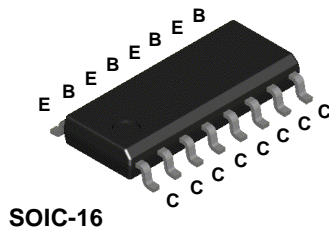

NMT2222

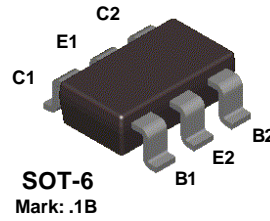

NPN General Purpose Amplifier

This device is for use as a medium power amplifier and switch requiring collector currents up to 500 mA. Sourced from Process 19.

Absolute Maximum Ratings* TA = 25°C unless otherwise noted

Symbol	Parameter	Value	Units
V _{CEO}	Collector-Emitter Voltage	40	V
V _{CBO}	Collector-Base Voltage	75	V
V _{EBO}	Emitter-Base Voltage	6.0	V
I _C	Collector Current - Continuous	1.0	A
T _J , T _{stg}	Operating and Storage Junction Temperature Range	-55 to +150	°C

* These ratings are limiting values above which the serviceability of any semiconductor device may be impaired.

NOTES:

- 1) These ratings are based on a maximum junction temperature of 150 degrees C.
- 2) These are steady state limits. The factory should be consulted on applications involving pulsed or low duty cycle operations.

PN2222A / MMBT2222A / MMPQ2222 / NMT2222 / PZT2222A

NPN General Purpose Amplifier

(continued)

Electrical Characteristics

TA = 25°C unless otherwise noted

Symbol	Parameter	Test Conditions	Min	Max	Units
OFF CHARACTERISTICS					
$V_{(BR)CEO}$	Collector-Emitter Breakdown Voltage*	$I_C = 10 \text{ mA}, I_B = 0$	40		V
$V_{(BR)CBO}$	Collector-Base Breakdown Voltage	$I_C = 10 \text{ } \mu\text{A}, I_E = 0$	75		V
$V_{(BR)EBO}$	Emitter-Base Breakdown Voltage	$I_E = 10 \text{ } \mu\text{A}, I_C = 0$	6.0		V
I_{CEX}	Collector Cutoff Current	$V_{CE} = 60 \text{ V}, V_{EB(OFF)} = 3.0 \text{ V}$		10	nA
I_{CBO}	Collector Cutoff Current	$V_{CB} = 60 \text{ V}, I_E = 0$ $V_{CB} = 60 \text{ V}, I_E = 0, T_A = 150^\circ\text{C}$		0.01 10	μA μA
I_{EBO}	Emitter Cutoff Current	$V_{EB} = 3.0 \text{ V}, I_C = 0$		10	nA
I_{BL}	Base Cutoff Current	$V_{CE} = 60 \text{ V}, V_{EB(OFF)} = 3.0 \text{ V}$		20	nA

ON CHARACTERISTICS

h_{FE}	DC Current Gain	$I_C = 0.1 \text{ mA}, V_{CE} = 10 \text{ V}$ $I_C = 1.0 \text{ mA}, V_{CE} = 10 \text{ V}$ $I_C = 10 \text{ mA}, V_{CE} = 10 \text{ V}$ $I_C = 10 \text{ mA}, V_{CE} = 10 \text{ V}, T_A = -55^\circ\text{C}$ $I_C = 150 \text{ mA}, V_{CE} = 10 \text{ V}^*$ $I_C = 150 \text{ mA}, V_{CE} = 1.0 \text{ V}^*$ $I_C = 500 \text{ mA}, V_{CE} = 10 \text{ V}^*$	35 50 75 35 100 50 40	300	
$V_{CE(sat)}$	Collector-Emitter Saturation Voltage*	$I_C = 150 \text{ mA}, I_B = 15 \text{ mA}$ $I_C = 500 \text{ mA}, I_B = 50 \text{ mA}$		0.3 1.0	V V
$V_{BE(sat)}$	Base-Emitter Saturation Voltage*	$I_C = 150 \text{ mA}, I_B = 1.0 \text{ mA}$ $I_C = 500 \text{ mA}, I_B = 5.0 \text{ mA}$	0.6	1.2 2.0	V V

SMALL SIGNAL CHARACTERISTICS (except MMPQ2222 and NMT2222)

f_T	Current Gain - Bandwidth Product	$I_C = 20 \text{ mA}, V_{CE} = 20 \text{ V}, f = 100 \text{ MHz}$	300		MHz
C_{obo}	Output Capacitance	$V_{CB} = 10 \text{ V}, I_E = 0, f = 100 \text{ kHz}$		8.0	pF
C_{ibo}	Input Capacitance	$V_{EB} = 0.5 \text{ V}, I_C = 0, f = 100 \text{ kHz}$		25	pF
τ_b/C_C	Collector Base Time Constant	$I_C = 20 \text{ mA}, V_{CB} = 20 \text{ V}, f = 31.8 \text{ MHz}$		150	pS
NF	Noise Figure	$I_C = 100 \text{ } \mu\text{A}, V_{CE} = 10 \text{ V},$ $R_S = 1.0 \text{ k}\Omega, f = 1.0 \text{ kHz}$		4.0	dB
$Re(h_{ie})$	Real Part of Common-Emitter High Frequency Input Impedance	$I_C = 20 \text{ mA}, V_{CE} = 20 \text{ V}, f = 300 \text{ MHz}$		60	Ω

SWITCHING CHARACTERISTICS (except MMPQ2222 and NMT2222)

t_d	Delay Time	$V_{CC} = 30 \text{ V}, V_{BE(OFF)} = 0.5 \text{ V},$		10	ns
t_r	Rise Time	$I_C = 150 \text{ mA}, I_{B1} = 15 \text{ mA}$		25	ns
t_s	Storage Time	$V_{CC} = 30 \text{ V}, I_C = 150 \text{ mA},$		225	ns
t_f	Fall Time	$I_{B1} = I_{B2} = 15 \text{ mA}$		60	ns

*Pulse Test: Pulse Width $\leq 300 \text{ } \mu\text{s}$, Duty Cycle $\leq 2.0\%$

Spice Model

NPN (Is=14.34f Xti=3 Eg=1.11 Vaf=74.03 Bf=255.9 Ne=1.307 Ise=14.34f Ikf=.2847 Xtb=1.5 Br=6.092 Nc=2 Isc=0 Ikr=0 Rc=1 Cjc=7.306p Mjc=.3416 Vjc=.75 Fc=.5 Cje=22.01p Mje=.377 Vje=.75 Tr=46.91n Tf=411.1p Itf=.6 Vtf=1.7 Xtf=3 Rb=10)

PN2222A / MMBT2222A / MMPQ2222 / NMT2222 / PZT2222A

NPN General Purpose Amplifier

(continued)

Thermal Characteristics

TA = 25°C unless otherwise noted

Symbol	Characteristic	Max		Units
		PN2222A	*PZT2222A	
P _D	Total Device Dissipation Derate above 25°C	625	1,000	mW
		5.0	8.0	mW/°C
R _{θJC}	Thermal Resistance, Junction to Case	83.3		°C/W
R _{θJA}	Thermal Resistance, Junction to Ambient	200	125	°C/W

Symbol	Characteristic	Max		Units
		**MMBT2222A	MMPQ2222	
P _D	Total Device Dissipation Derate above 25°C	350	1,000	mW
		2.8	8.0	mW/°C
R _{θJA}	Thermal Resistance, Junction to Ambient Effective 4 Die Each Die	357		°C/W
			125	°C/W
			240	°C/W

* Device mounted on FR-4 PCB 36 mm X 18 mm X 1.5 mm; mounting pad for the collector lead min. 6 cm².

** Device mounted on FR-4 PCB 1.6" X 1.6" X 0.06."

Typical Characteristics

Typical Pulsed Current Gain vs Collector Current

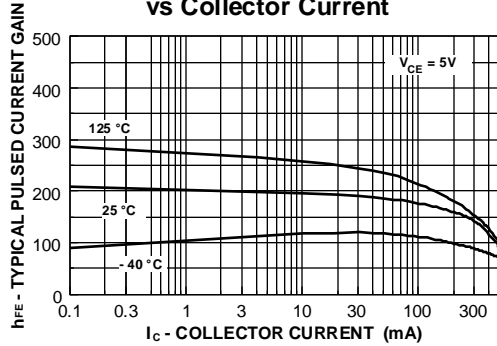

Collector-Emitter Saturation Voltage vs Collector Current

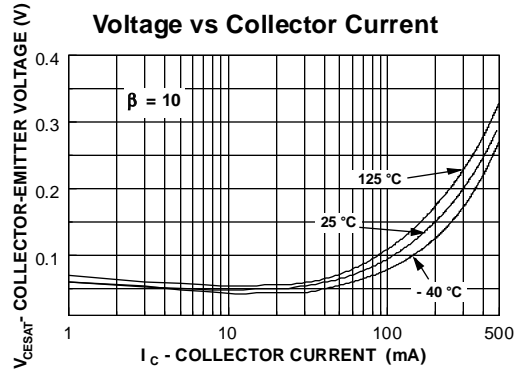

Base-Emitter Saturation Voltage vs Collector Current

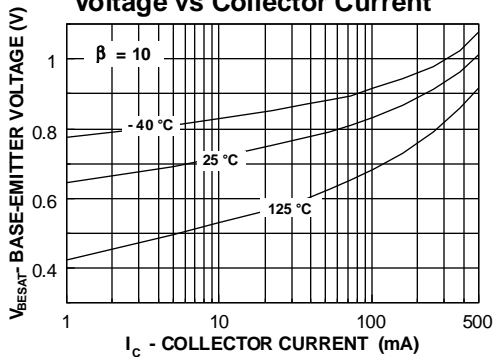

Base-Emitter ON Voltage vs Collector Current

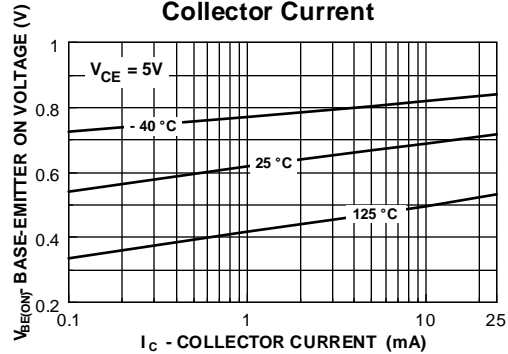

PN2222A / MMBT2222A / NMMPQ2222 / NMT2222 / PZT2222A

NPN General Purpose Amplifier

(continued)

PN2222A / MMBT2222A / NMMPQ2222 / NMT2222 / PZT2222A

Typical Characteristics (continued)

Collector-Cutoff Current vs Ambient Temperature

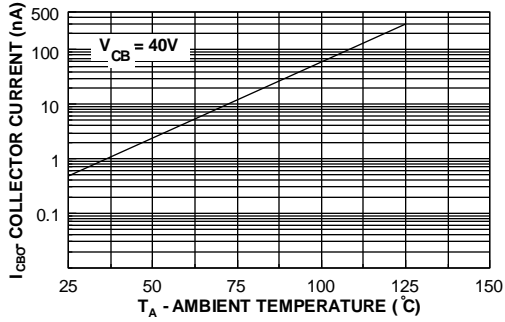

Emitter Transition and Output Capacitance vs Reverse Bias Voltage

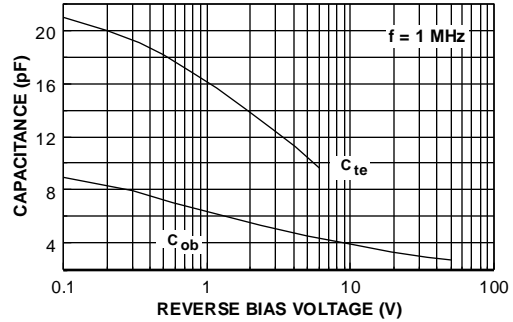

Turn On and Turn Off Times vs Collector Current

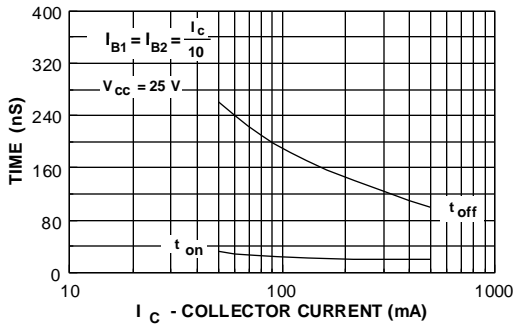

Switching Times vs Collector Current

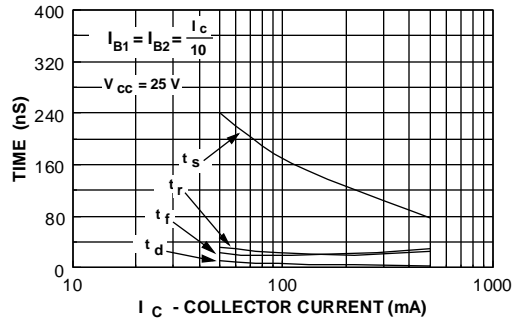

Power Dissipation vs Ambient Temperature

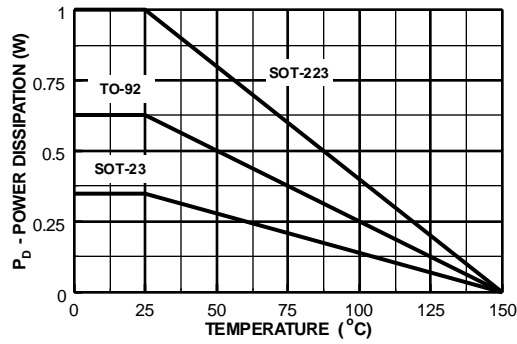

Test Circuits

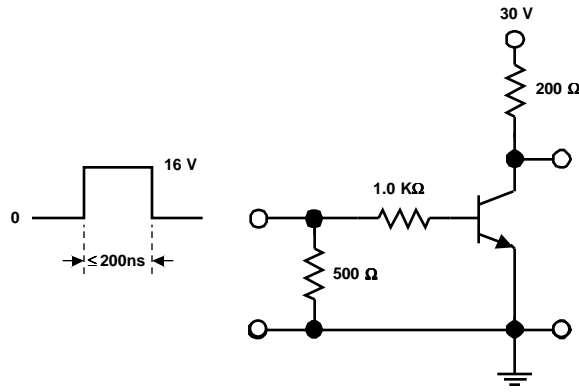

FIGURE 1: Saturated Turn-On Switching Time

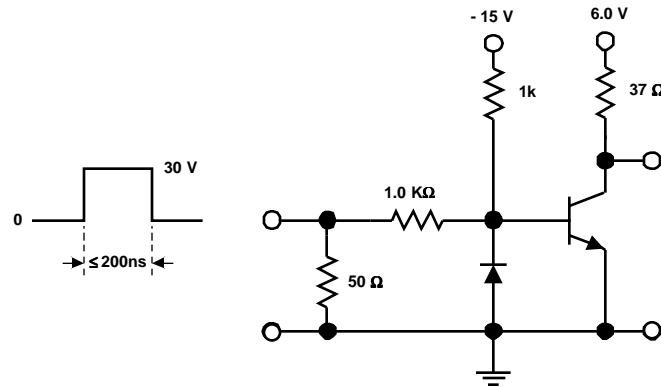

FIGURE 2: Saturated Turn-Off Switching Time