

T-39-15

REPETITIVE AVALANCHE AND dv/dt RATED*

HEXFET® TRANSISTORS

IRFP250

IRFP251

IRFP252

IRFP253

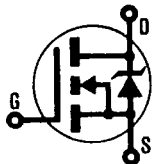

N-CHANNEL

200 Volt, 0.085 Ohm HEXFET
TO-247AC (TO-3P) Plastic Package

The HEXFET® technology is the key to International Rectifier's advanced line of power MOSFET transistors. The efficient geometry and unique processing of this latest "State of the Art" design achieves: very low on-state resistance combined with high transconductance; superior reverse energy and diode recovery dv/dt capability.

The HEXFET transistors also feature all of the well established advantages of MOSFETs such as voltage control, very fast switching, ease of paralleling and temperature stability of the electrical parameters.

They are well suited for applications such as switching power supplies, motor controls, inverters, choppers, audio amplifiers and high energy pulse circuits.

Product Summary

Part Number	BV _{DSS}	R _{DS(on)}	I _D
IRFP250	200V	0.085Ω	33A
IRFP251	150V	0.085Ω	33A
IRFP252	200V	0.120Ω	27A
IRFP253	150V	0.120Ω	27A

Features:

- Isolated Central Mounting Hole
- Repetitive Avalanche Ratings
- Dynamic dv/dt Rating
- Simple Drive Requirements
- Ease of Paralleling

CASE STYLE AND DIMENSIONS

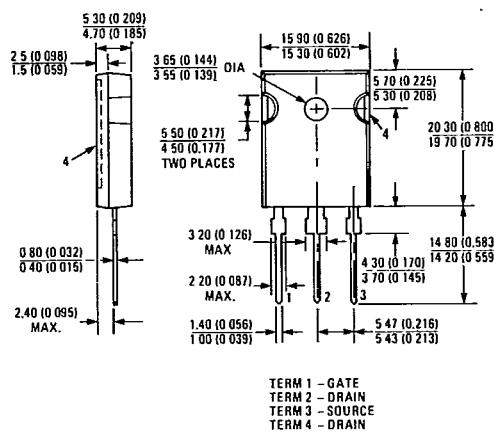
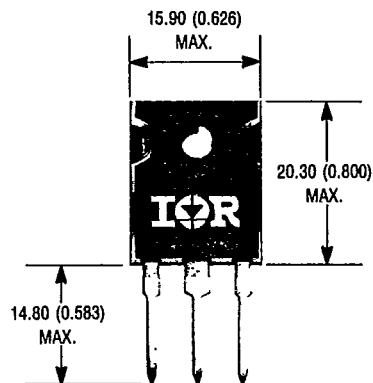

Conforms to JEDEC Outline TO-247AC (TO 3P)
Dimensions in Millimeters and (Inches)

*This data sheet applies to product with batch codes that begin with a digit, ie. 2A3B
C-499

IRFP250, IRFP251, IRFP252, IRFP253 Devices

T-39-15

Absolute Maximum Ratings

Parameter	IRFP250, IRFP251	IRFP252, IRFP253	Units
$I_D @ T_C = 25^\circ\text{C}$ Continuous Drain Current	33	27	A
$I_D @ T_C = 100^\circ\text{C}$ Continuous Drain Current	21	17	A
I_{DM} Pulsed Drain Current ^①	130	110	A
$P_D @ T_C = 25^\circ\text{C}$ Max. Power Dissipation	180		W
Linear Derating Factor	1.4		W/K ^②
V_{GS} Gate-to-Source Voltage	± 20		V
E_{AS} Single Pulse Avalanche Energy ^③	810 (See Fig. 14)		mJ
I_{AR} Avalanche Current ^④ (Repetitive or Non-Repetitive)	33 (See E_{AR})		A
E_{AR} Repetitive Avalanche Energy ^④	18 (See I_{AR})		mJ
dv/dt Peak Diode Recovery dv/dt ^⑤	5.0 (See Fig. 17)		V/ns
T_J Operating Junction Temperature Range	-55 to 150		$^\circ\text{C}$
T_{STG} Storage Temperature Range	-55 to 150		$^\circ\text{C}$
Lead Temperature	300 (0.063 in. (1.6mm) from case for 10s)		$^\circ\text{C}$

Electrical Characteristics @ $T_J = 25^\circ\text{C}$ (Unless Otherwise Specified)

Parameter	Type	Min.	Typ.	Max.	Units	Test Conditions
BV_{DSS} Drain-to-Source Breakdown Voltage	IRFP250 IRFP252 IRFP251 IRFP253	200 150	—	—	V	$V_{GS} = 0V, I_D = 250\mu\text{A}$
$R_{DS(on)}$ Static Drain-to-Source On-State Resistance ^⑥	IRFP250 IRFP251 IRFP252 IRFP253	— —	0.070 0.085	0.085 0.12	Ω	$V_{GS} = 10V, I_D = 17A$
$I_{D(on)}$ On-State Drain Current ^⑦	IRFP250 IRFP251 IRFP252 IRFP253	33 27	—	—	A	$V_{DS} > I_{D(on)} \times R_{DS(on)}$ Max. $V_{GS} = 10V$
$V_{GS(th)}$ Gate Threshold Voltage	ALL	2.0	—	4.0	V	$V_{DS} = V_{GS}, I_D = 250\mu\text{A}$
g_{fs} Forward Transconductance ^⑧	ALL	13	19	—	S(U)	$V_{DS} \geq 50V, I_{DS} = 17A$
I_{DSS} Zero Gate Voltage Drain Current	ALL	—	—	250 1000	μA	$V_{DS} = \text{Max. Rating}, V_{GS} = 0V$ $V_{DS} = 0.8 \times \text{Max. Rating}$ $V_{GS} = 0V, T_J = 125^\circ\text{C}$
I_{GSS} Gate-to-Source Leakage Forward	ALL	—	—	500	nA	$V_{GS} = 20V$
I_{GSS} Gate-to-Source Leakage Reverse	ALL	—	—	-500	nA	$V_{GS} = -20V$
Q_g Total Gate Charge	ALL	—	80	120	nC	$V_{GS} = 10V, I_D = 30A$ $V_{DS} = 0.8 \times \text{Max. Rating}$ See Fig. 16
Q_{gs} Gate-to-Source Charge	ALL	—	12	19	nC	(Independent of operating temperature)
Q_{gd} Gate-to-Drain ("Miller") Charge	ALL	—	43	64	nC	(Independent of operating temperature)
$t_{d(on)}$ Turn-On Delay Time	ALL	—	20	30	ns	$V_{DD} = 100V, I_D \approx 30A, R_G = 6.2\Omega$
t_r Rise Time	ALL	—	120	180	ns	$R_D = 3.3\Omega$
$t_{d(off)}$ Turn-Off Delay Time	ALL	—	69	100	ns	See Fig. 15
t_f Fall Time	ALL	—	80	120	ns	(Independent of operating temperature)
L_D Internal Drain Inductance	ALL	—	4.5	—	nH	Measured from the drain lead, 6mm (0.25 in.) from package to center of die.
L_S Internal Source Inductance	ALL	—	7.5	—	nH	Measured from the source lead, 6mm (0.25 in.) from package to source bonding pad.
C_{iss} Input Capacitance	ALL	—	2600	—	pF	$V_{GS} = 0V, V_{DS} = 25V$
C_{oss} Output Capacitance	ALL	—	650	—	pF	$f = 1.0 \text{ MHz}$
C_{rss} Reverse Transfer Capacitance	ALL	—	150	—	pF	See Fig. 10



Source-Drain Diode Ratings and Characteristics

Parameter	Type	Min.	Typ.	Max.	Units	Test Conditions
I_S Continuous Source Current (Body Diode)	ALL	-	-	33	A	Modified MOSFET symbol showing the Integral Reverse p-n junction rectifier. 
I_{SM} Pulsed Source Current (Body Diode) ①	ALL	-	-	130	A	
V_{SD} Diode Forward Voltage ②	ALL	-	-	2.0	V	$T_J = 25^\circ\text{C}$, $I_S = 33\text{A}$, $V_{GS} = 0\text{V}$
t_{rr} Reverse Recovery Time	ALL	140	300	630	ns	$T_J = 25^\circ\text{C}$, $I_F = 30\text{A}$, $di/dt = 100\text{A}/\mu\text{s}$
Q_{RR} Reverse Recovery Charge	ALL	1.8	3.8	8.1	μC	
t_{on} Forward Turn-On Time	ALL	Intrinsic turn-on time is negligible. Turn-on speed is substantially controlled by $L_S + L_D$.				

Thermal Resistance

R_{thJC} Junction-to-Case	ALL	-	-	0.70	K/W°	
R_{thCS} Case-to-Sink	ALL	-	0.24	-	K/W°	Mounting surface flat, smooth, and greased
R_{thJA} Junction-to-Ambient	ALL	-	-	40	K/W°	Typical socket mount
Mounting Torque	ALL	-	-	10	in. * lbs.	Standard 6-32 screw

① Repetitive Rating; Pulse width limited by maximum junction temperature (see figure 5) Refer to current HEXFET reliability report

② $I_{SD} \leq 33\text{A}$, $di/dt \leq 190\text{A}/\mu\text{s}$, $V_{DD} \leq BV_{DSS}$, $T_J \leq 150^\circ\text{C}$ Suggested $R_G = 6.2\Omega$

③ $\text{K/W} = ^\circ\text{C/W}$
 $\text{W/K} = \text{W}/^\circ\text{C}$

④ @ $V_{DD} = 50\text{V}$, Starting $T_J = 25^\circ\text{C}$, $L = 1.1\text{mH}$, $R_G = 25\Omega$, Peak $I_L = 33\text{A}$

⑤ Pulse width $\leq 300\mu\text{s}$; Duty Cycle $\leq 2\%$

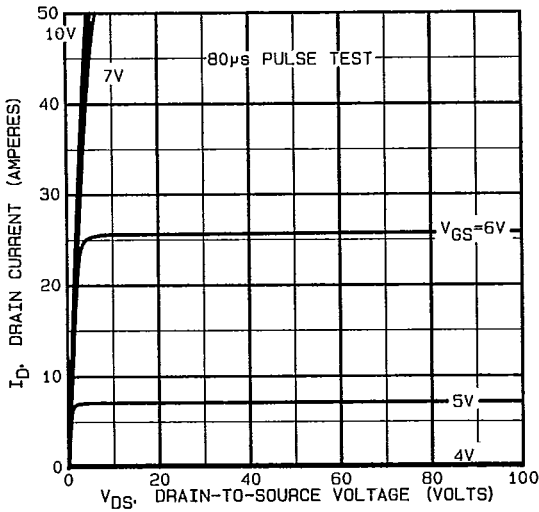

Fig. 1 — Typical Output Characteristics

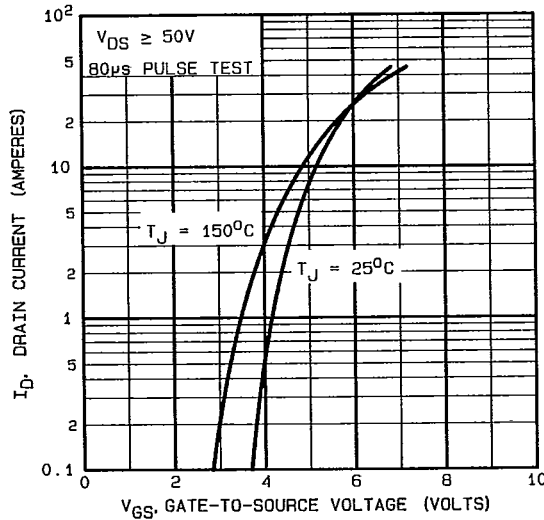

Fig. 2 — Typical Transfer Characteristics

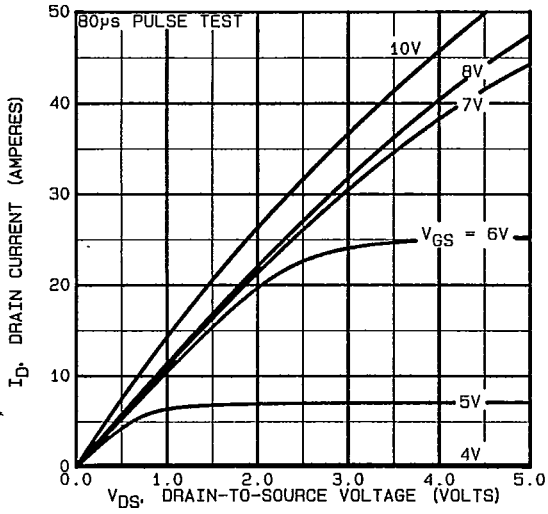

Fig. 3 — Typical Saturation Characteristics

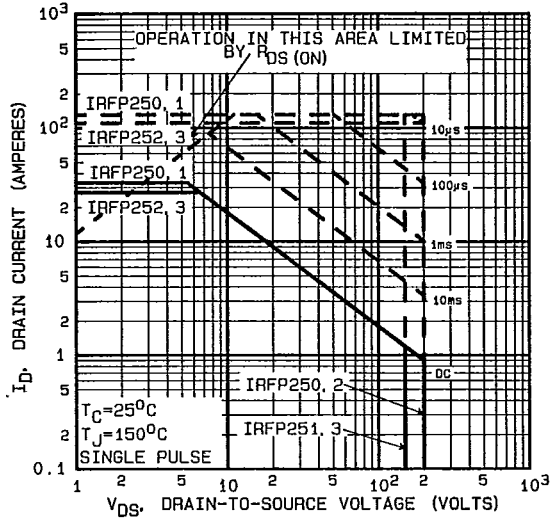

Fig. 4 — Maximum Safe Operating Area

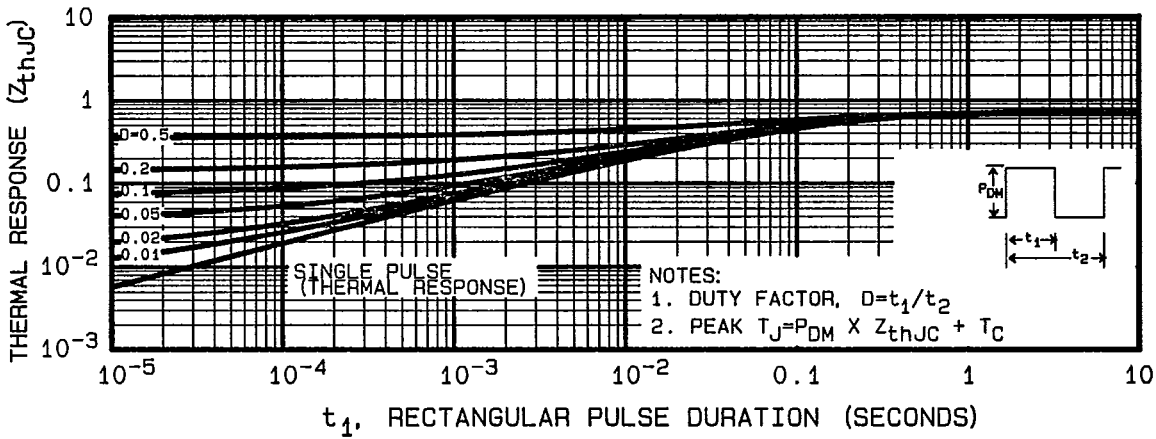

Fig. 5 — Maximum Effective Transient Thermal Impedance, Junction-to-Case Vs. Pulse Duration

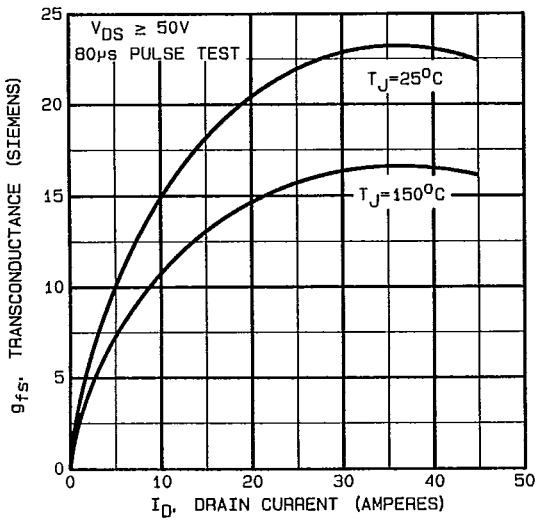

Fig. 6 — Typical Transconductance Vs. Drain Current

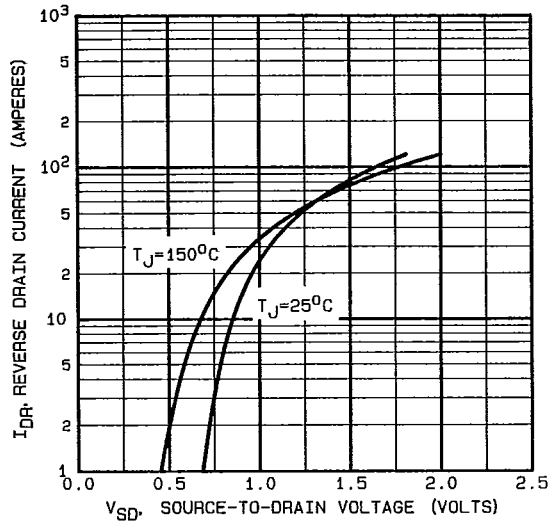

Fig. 7 — Typical Source-Drain Diode Forward Voltage

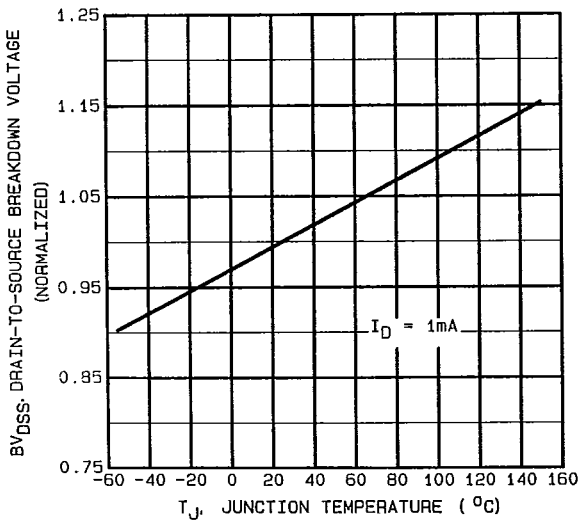

Fig. 8 — Breakdown Voltage Vs. Temperature

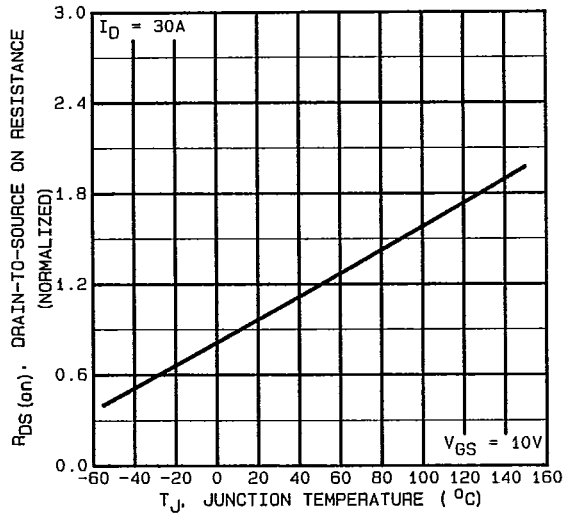

Fig. 9 — Normalized On-Resistance Vs. Temperature

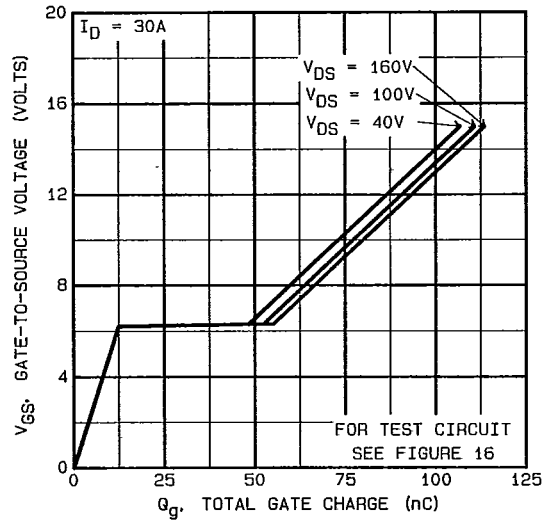
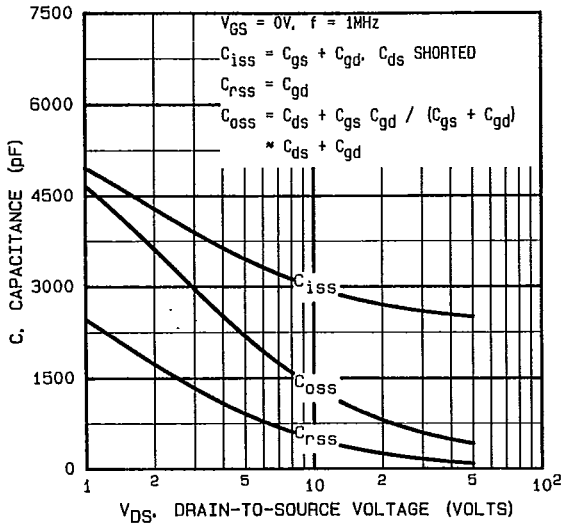

Fig. 10 — Typical Capacitance Vs. Drain-to-Source Voltage

Fig. 11 — Typical Gate Charge Vs. Gate-to-Source Voltage

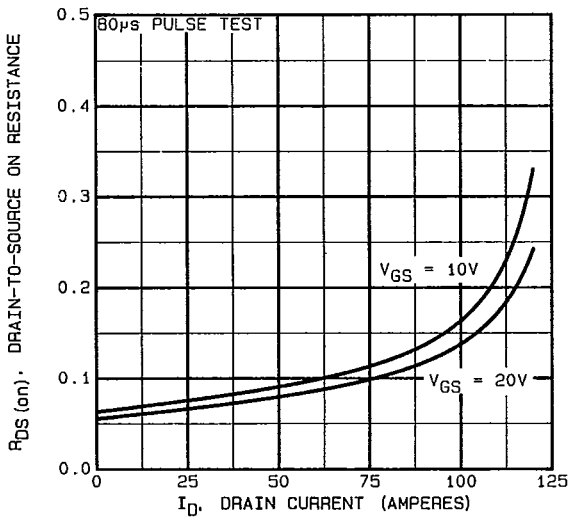

Fig. 12 — Typical On-Resistance Vs. Drain Current

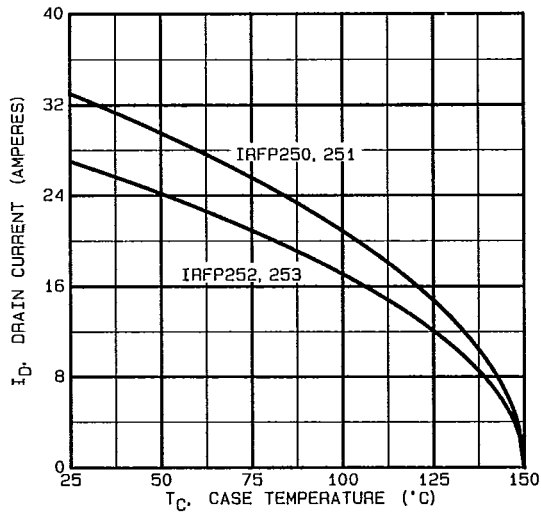

Fig. 13 — Maximum Drain Current Vs. Case Temperature

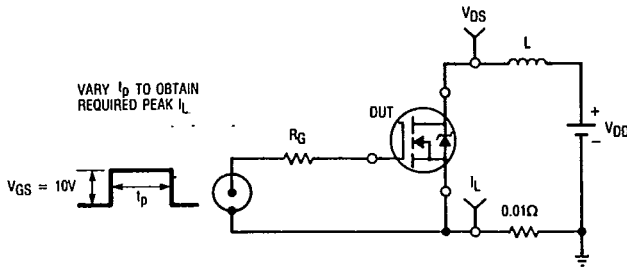

Fig. 14a — Unclamped Inductive Test Circuit

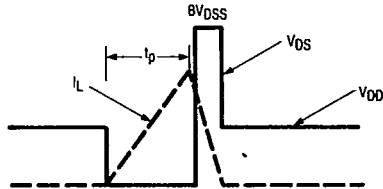

Fig. 14b — Unclamped Inductive Waveforms

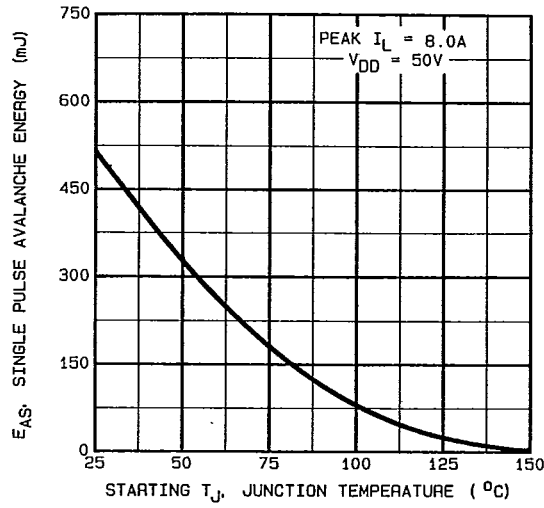

Fig. 14c — Maximum Avalanche Energy Vs. Starting Junction Temperature

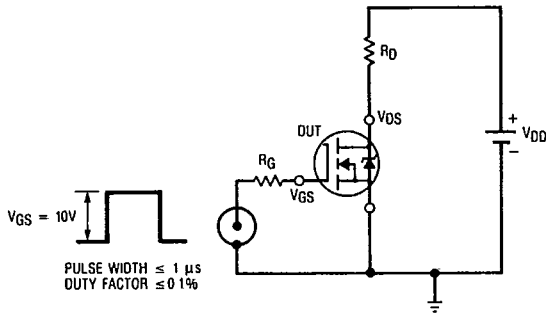

Fig. 15a — Switching Time Test Circuit

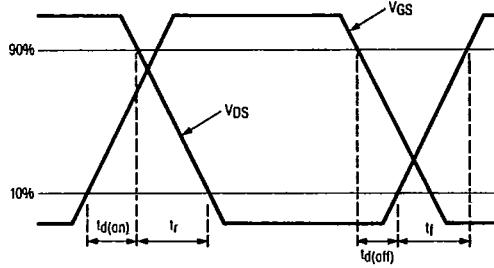

Fig. 15b — Switching Time Waveforms

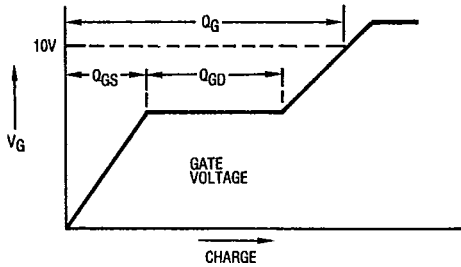

Fig. 16a — Basic Gate Charge Waveform

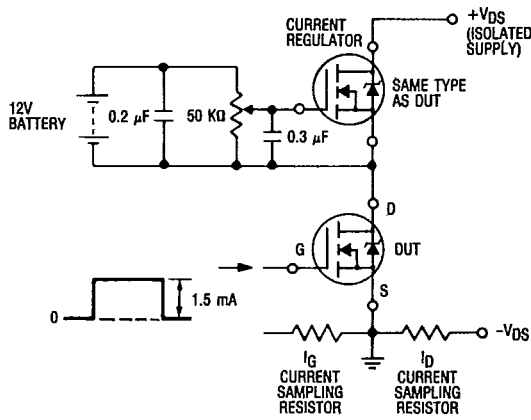

Fig. 16b — Gate Charge Test Circuit

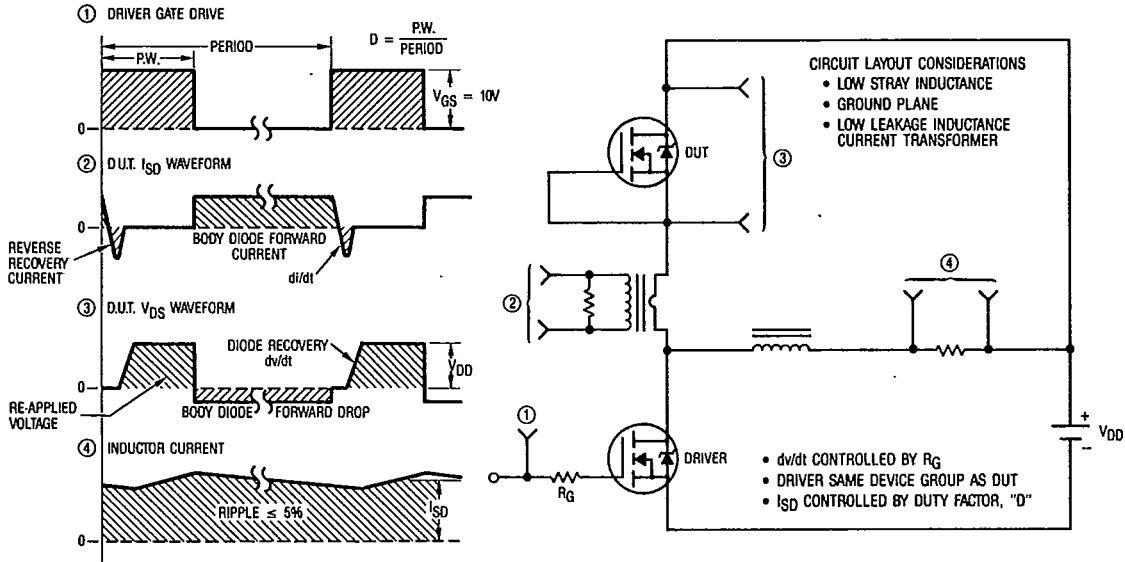

Fig. 17 — Peak Diode Recovery dv/dt Test Circuit