

PNP SILICON POWER TRANSISTORS

...designed for use in general power amplifier application

FEATURES:

- * Low Collector-Emitter Saturation Voltage
 $V_{CE(sat)} = 1.0V(\text{Max}) @ I_C=3.0A, I_B=0.3A$
- * DC Current Gain
 $hFE = 40-240 @ I_C = 0.5A$
- * Complementary to NPN 2SD526

PNP
2SB596

4.0 AMPERE
POWER
TRANSISTORS
80 VOLTS
30 WATTS

MAXIMUM RATINGS

Characteristic	Symbol	2SB596	Unit
Collector-Emitter Voltage	V_{CEO}	80	V
Collector-Base Voltage	V_{CBO}	80	V
Emitter-Base Voltage	V_{EBO}	5.0	V
Collector Current - Continuous	I_C	4.0	A
- Peak	I_{CM}	8.0	
Base current	I_B	2.0	A
Total Power Dissipation @ $T_C = 25^\circ\text{C}$	P_D	30	W
Derate above 25°C		0.24	W/ $^\circ\text{C}$
Operating and Storage Junction Temperature Range	T_J, T_{STG}	-55 to +150	$^\circ\text{C}$

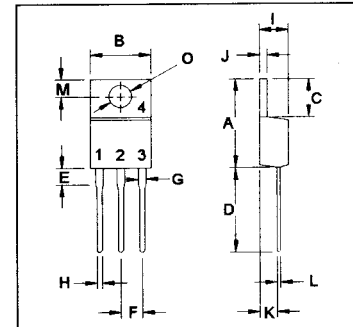
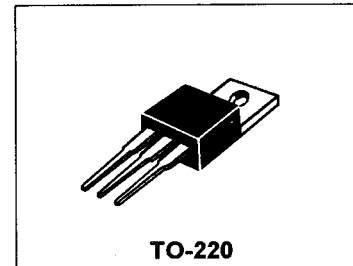

PIN 1.BASE
2.COLLECTOR
3.EMITTER
4.COLLECTOR(CASE)

DIM	MILLIMETERS	
	MIN	MAX
A	14.68	15.31
B	9.78	10.42
C	5.01	6.52
D	13.06	14.62
E	3.57	4.07
F	2.42	3.66
G	1.12	1.36
H	0.72	0.96
I	4.22	4.98
J	1.14	1.38
K	2.20	2.97
L	0.33	0.55
M	2.48	2.98
O	3.70	3.90

THERMAL CHARACTERISTICS

Characteristic	Symbol	Max	Unit
Thermal Resistance Junction to Case	$R_{\theta jc}$	4.16	$^\circ\text{C}/\text{W}$

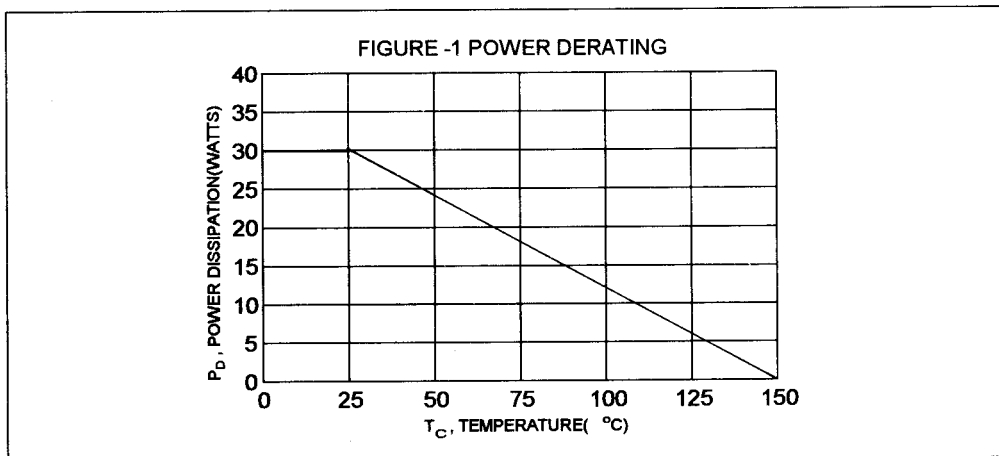

ELECTRICAL CHARACTERISTICS ($T_c = 25^\circ\text{C}$ unless otherwise noted)

Characteristic	Symbol	Min	Max	Unit
----------------	--------	-----	-----	------

OFF CHARACTERISTICS

Collector-Emitter Breakdown Voltage ($I_C = 50 \text{ mA}$, $I_B = 0$)	$V_{(BR)CEO}$	80		V
Emitter-Base Breakdown Voltage ($I_C = 10 \text{ mA}$, $I_C = 0$)	$V_{(BR)EBO}$	5.0		V
Collector Cutoff Current ($V_{CB} = 80 \text{ V}$, $I_E = 0$)	I_{CBO}		30	μA
Emitter Cutoff Current ($V_{EB} = 5.0 \text{ V}$, $I_C = 0$)	I_{EBO}		100	μA

ON CHARACTERISTICS (1)

DC Current Gain ($I_C = 0.5 \text{ A}$, $V_{CE} = 5.0 \text{ V}$) * ($I_C = 3.0 \text{ A}$, $V_{CE} = 5.0 \text{ V}$)	$h_{FE(2)}$ h_{FE}	40 15	240	
Collector-Emitter Saturation Voltage ($I_C = 3.0 \text{ A}$, $I_B = 300 \text{ mA}$)	$V_{CE(sat)}$		1.7	V
Base-Emitter On Voltage ($I_C = 3.0 \text{ A}$, $V_{CE} = 5.0 \text{ V}$)	$V_{BE(on)}$		1.5	V

DYNAMIC CHARACTERISTICS

Current-Gain-Bandwidth Product ($I_C = 0.5 \text{ A}$, $V_{CE} = 5.0 \text{ V}$, $f = 1.0 \text{ MHz}$)	f_T	3.0		MHz
--	-------	-----	--	-----

(1) Pulse Test: Pulse Width = 300 μs , Duty Cycle $\leq 2.0\%$ * $h_{FE(2)}$ Classification :

40	R	80	70	O	140	120	Y	240
----	---	----	----	---	-----	-----	---	-----

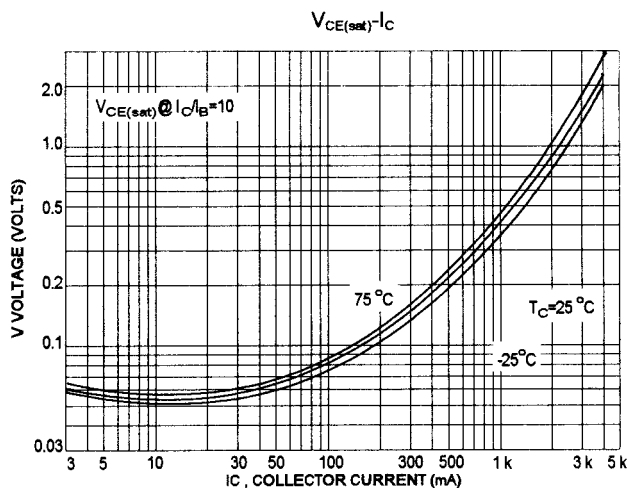
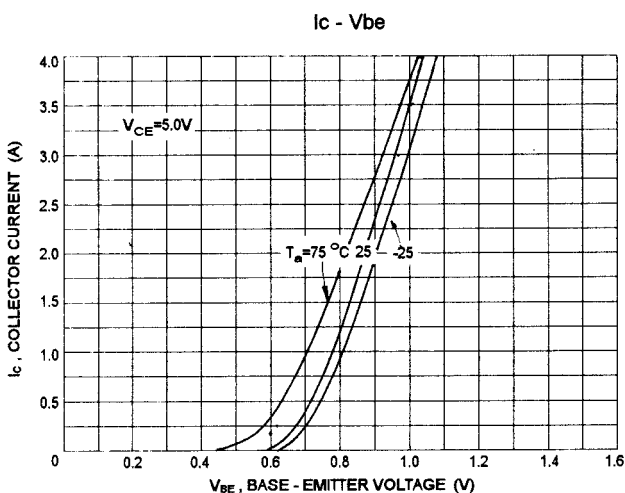
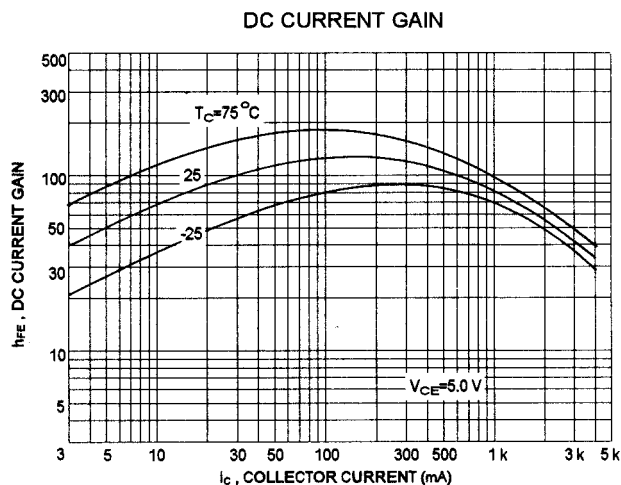
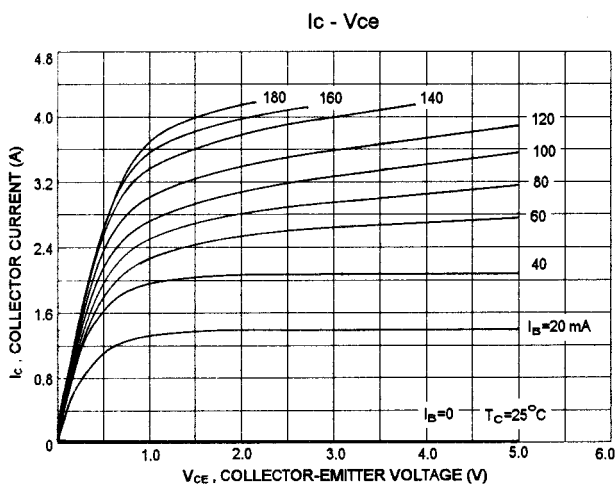

ACTIVE-REGION SAFE OPERATING AREA (SOA)

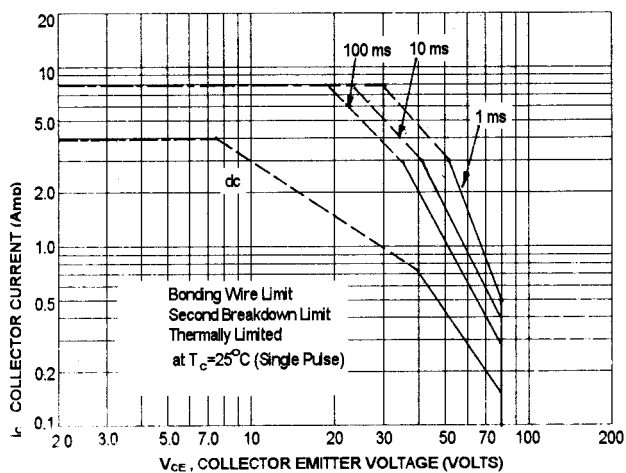

There are two limitation on the power handling ability of a transistor: average junction temperature and second breakdown safe operating area curves indicate $I_C - V_{CE}$ limits of the transistor that must be observed for reliable operation i.e., the transistor must not be subjected to greater dissipation than curves indicate.

The data of SOA curve is base on $T_{J(PK)} = 150^\circ\text{C}$; T_C is variable depending on conditions. second breakdown pulse limits are valid for duty cycles to 10% provided $T_{J(PK)} \leq 150^\circ\text{C}$. At high case temperatures, thermal limitation will reduce the power that can be handled to values less than the limitations imposed by second breakdown.